

ASPHALT SECTION
PAVED

PAVEMENT SECTION:

Pavement section must be designed by geotechnical engineer based on applicable soil and traffic load conditions.



TOWN of WAKE FOREST, NC
Manual of Specifications, Standards and Design

GREENWAY
ASPHALT PAVEMENT SECTION

Scale: Not To Scale	Detail #: 8.01
Revision Date: Feb., 2015	Sheet #: 1 of 1

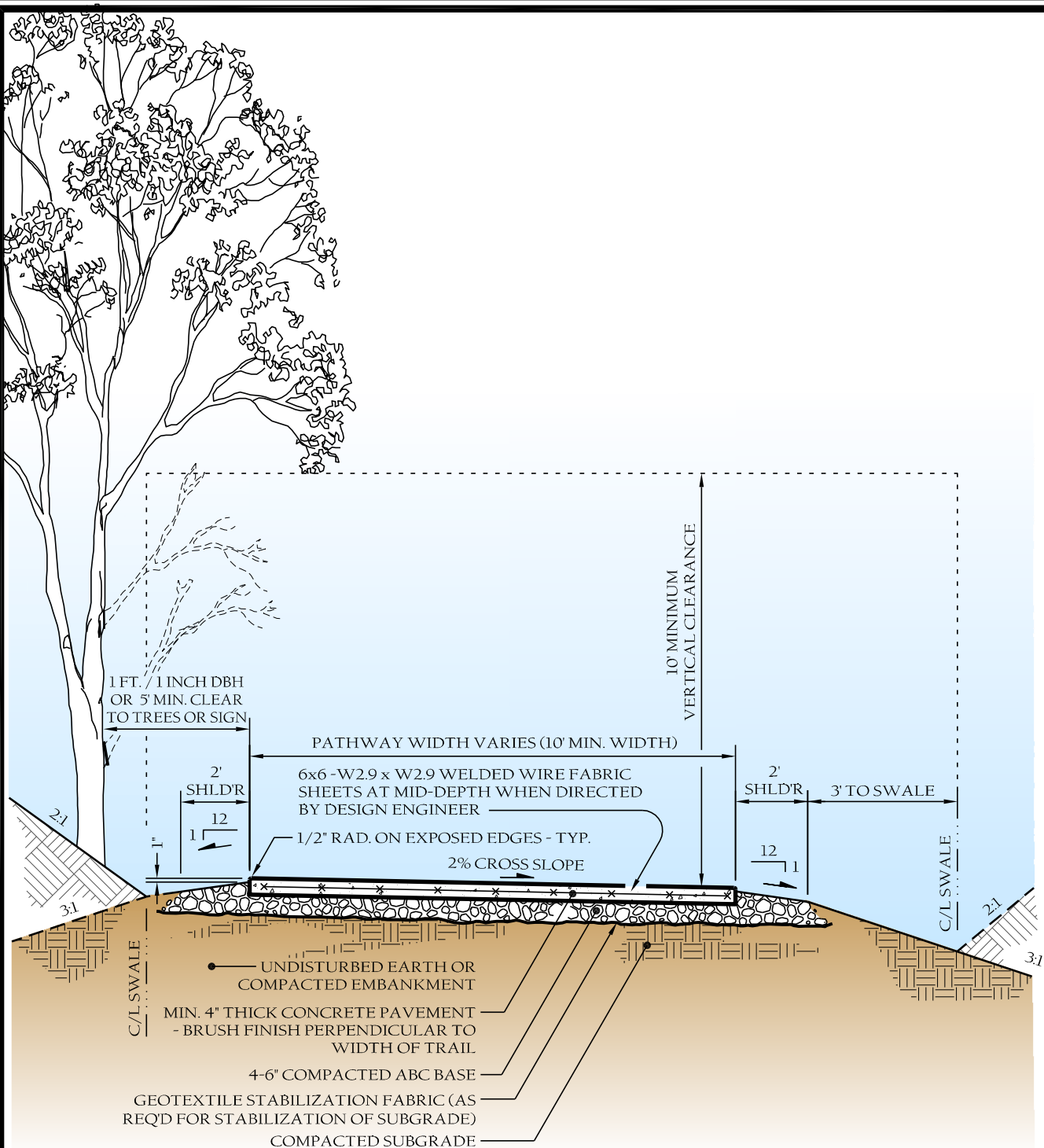

NOTES:

CONCRETE SURFACED TRAIL OPTION
PAVED

1. Place saw-cut transverse control joints at maximum of 12' o/c or as otherwise shown on plans.
2. Place transverse expansion joints as shown on plans.
3. Trail section shown may be altered to conform to Geotechnical Investigation findings.
4. Concrete to be min. 3000 PSI @ 28 days air entrained.



TOWN of WAKE FOREST, NC
Manual of Specifications, Standards and Design

GREENWAY

CONCRETE SURFACED TRAIL OPTION

Scale: Not To Scale	Detail #: 8.02
Revision Date: Feb., 2015	Sheet #: 1 of 1

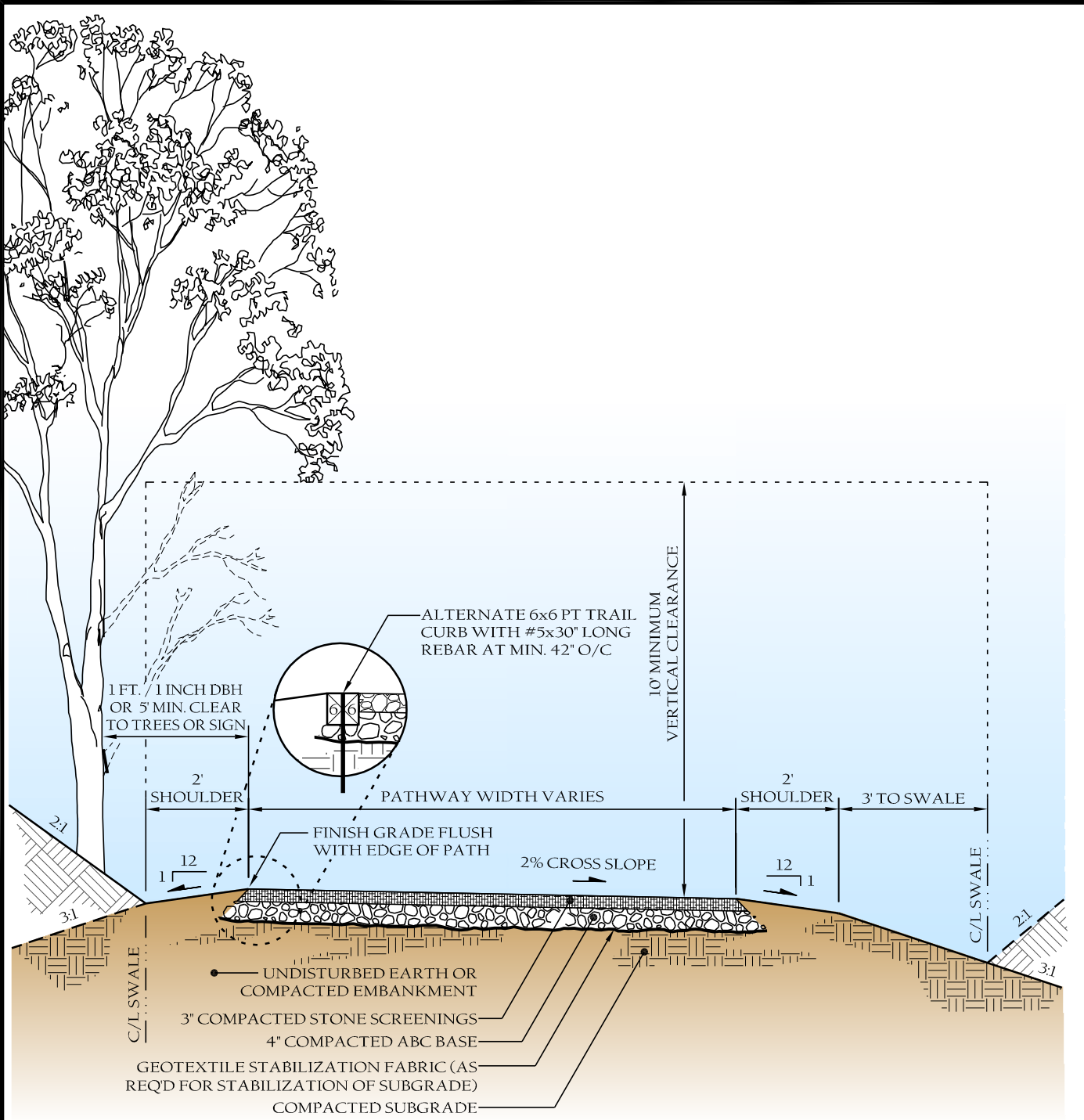

SOFT SURFACE STONE TRAIL
UNPAVED



TOWN of WAKE FOREST, NC
Manual of Specifications, Standards and Design

GREENWAY
SOFT SURFACE STONE TRAIL

Scale: Not To Scale	Detail #: 8.03
Revision Date: Feb., 2015	Sheet #: 1 of 1

**OTHER TRAIL SURFACING OPTIONS AVAILABLE,
SUBJECT TO APPROVAL BY TOWN ARE:**

- Rubberized surfaces.
- Limestone stabilized surfaces.
- Geotextile confinement surfaces.
- Permeable pavement (concrete or asphalt).
- Timber Boardwalks.

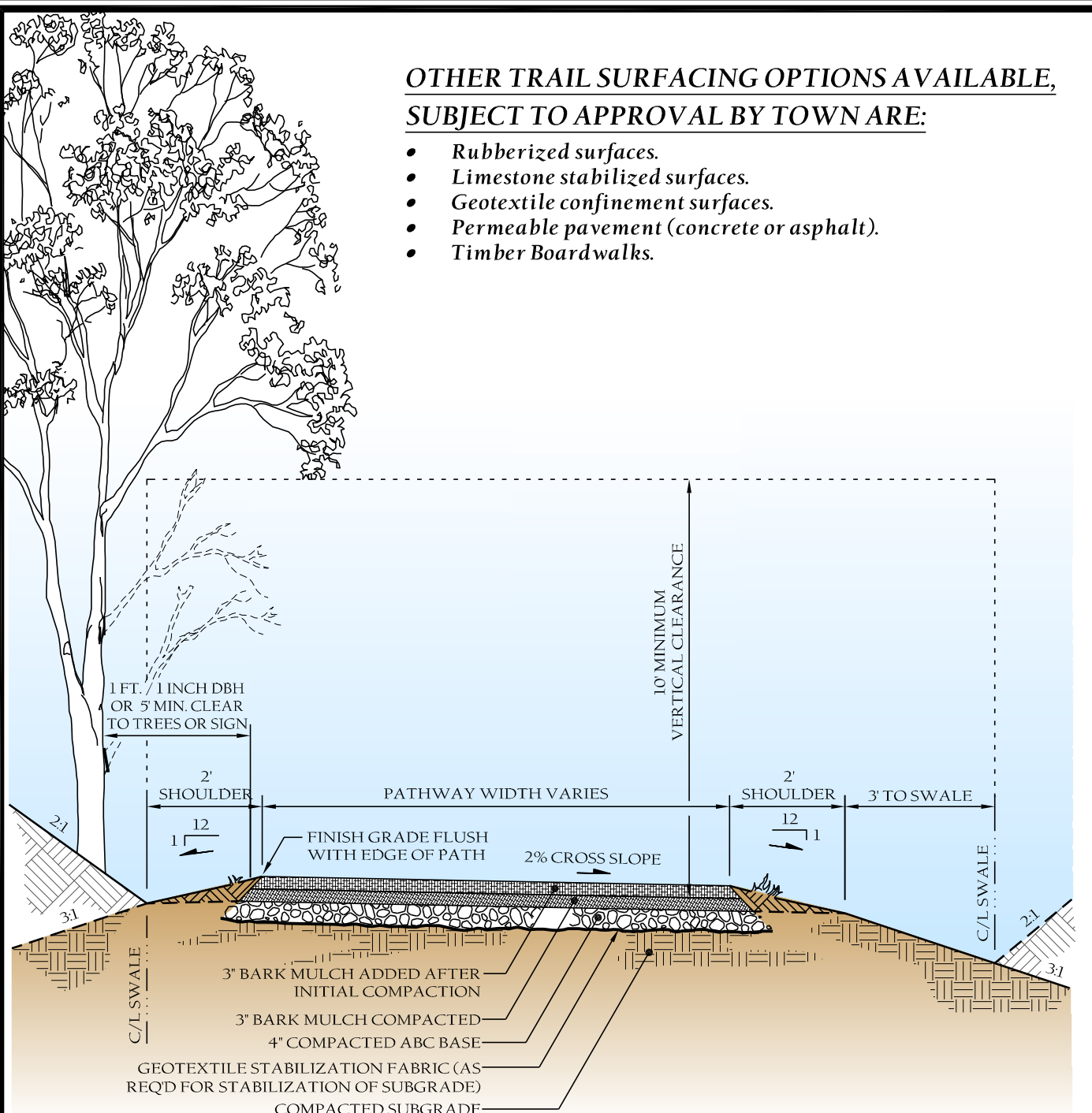

SOFT SURFACE BARK MULCH TRAIL
UNPAVED



TOWN of WAKE FOREST, NC
Manual of Specifications, Standards and Design

GREENWAY
SOFT SURFACE BARK MULCH TRAIL

Scale: Not To Scale	Detail #: 8.04
Revision Date: Feb., 2015	Sheet #: 1 of 1

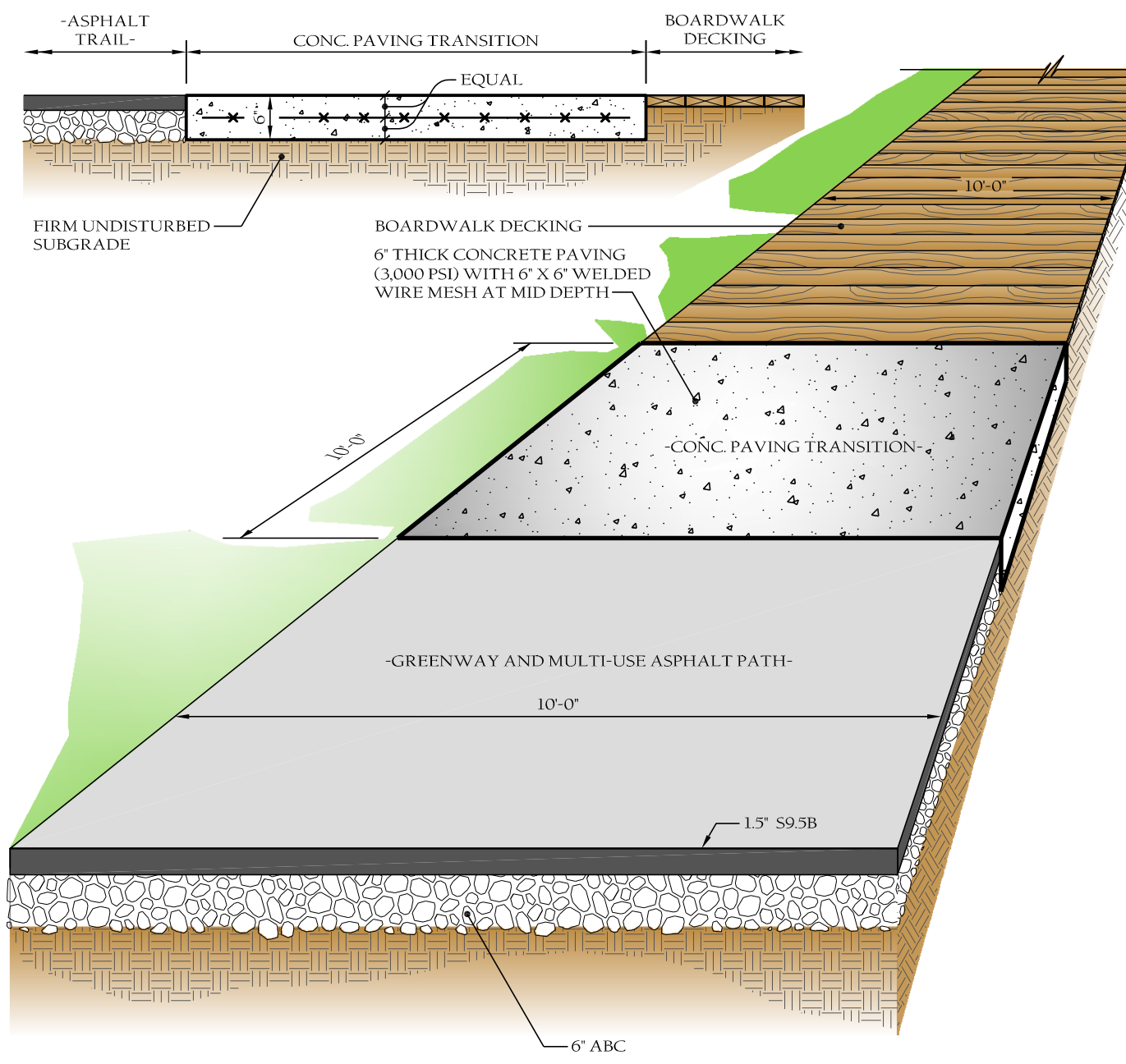

NOTES:

- 1. Concrete transition pad to be a minimum of 3,000 PSI @ 28 days air entrained.



TOWN of WAKE FOREST, NC
Manual of Specifications, Standards and Design

STANDARD BOARDWALK APPROACH

Scale: Not To Scale	Detail #: 8.05
Revision Date: Feb., 2015	Sheet #: 1 of 1

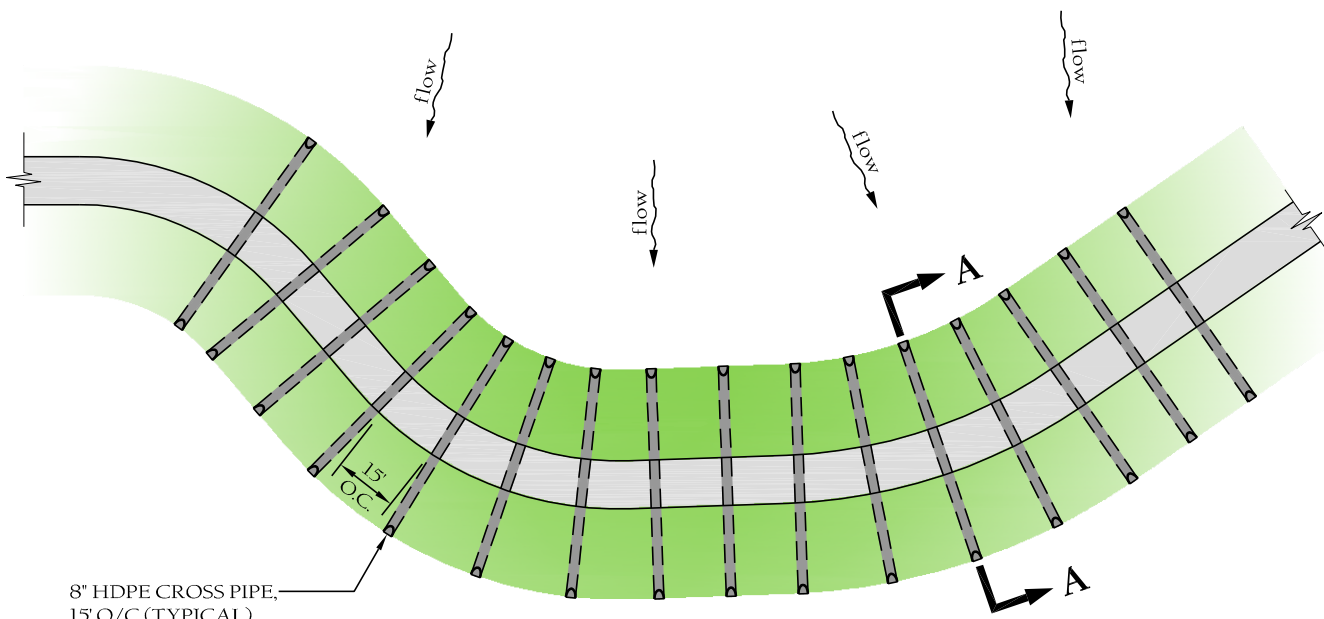

PLAN VIEW

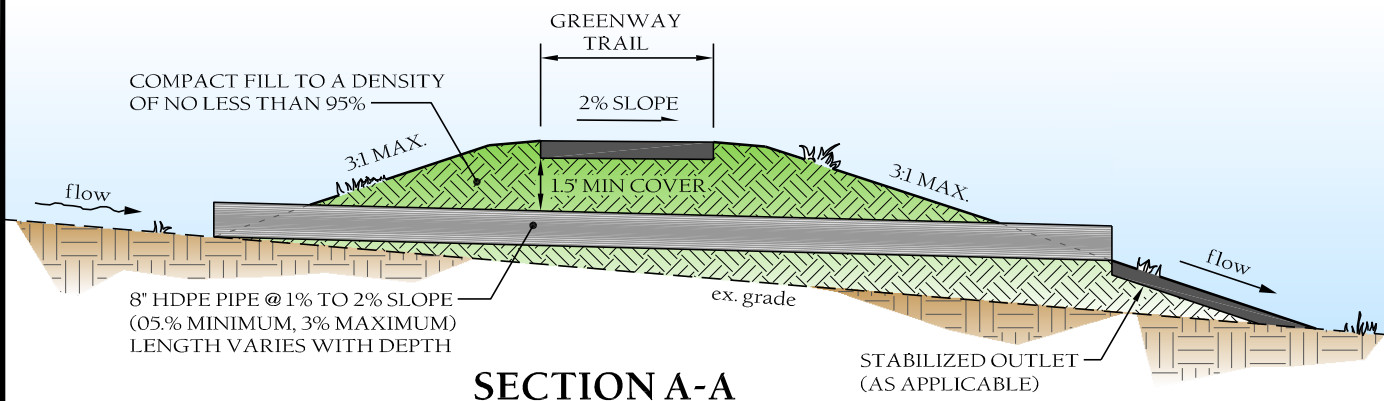

SECTION A-A

NOTES:

1. Concrete transition pad to be a minimum of 3,000 PSI air entrained @ 28 days.



TOWN of WAKE FOREST, NC
Manual of Specifications, Standards and Design

**GREENWAY TRAIL
DRAINAGE CROSSING**

Scale:
Not To Scale

Detail #:
8.06

Revision Date:
Feb., 2015

Sheet #:
1 of 1

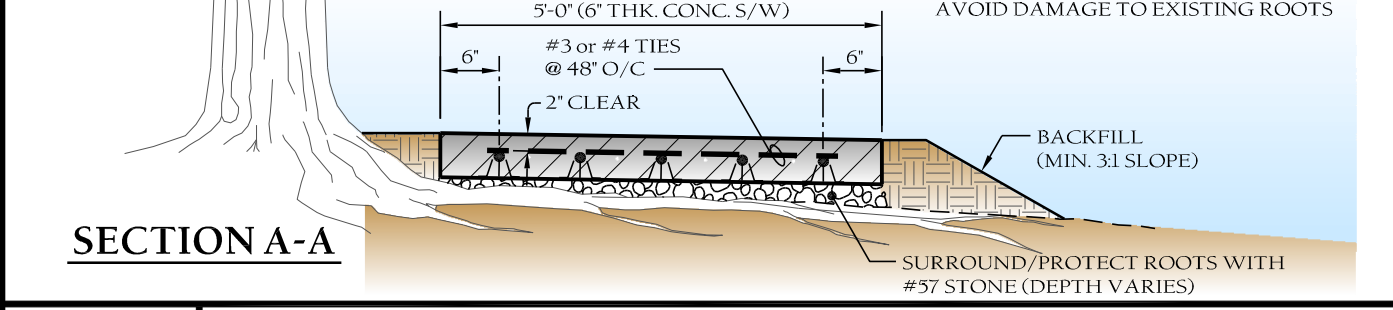
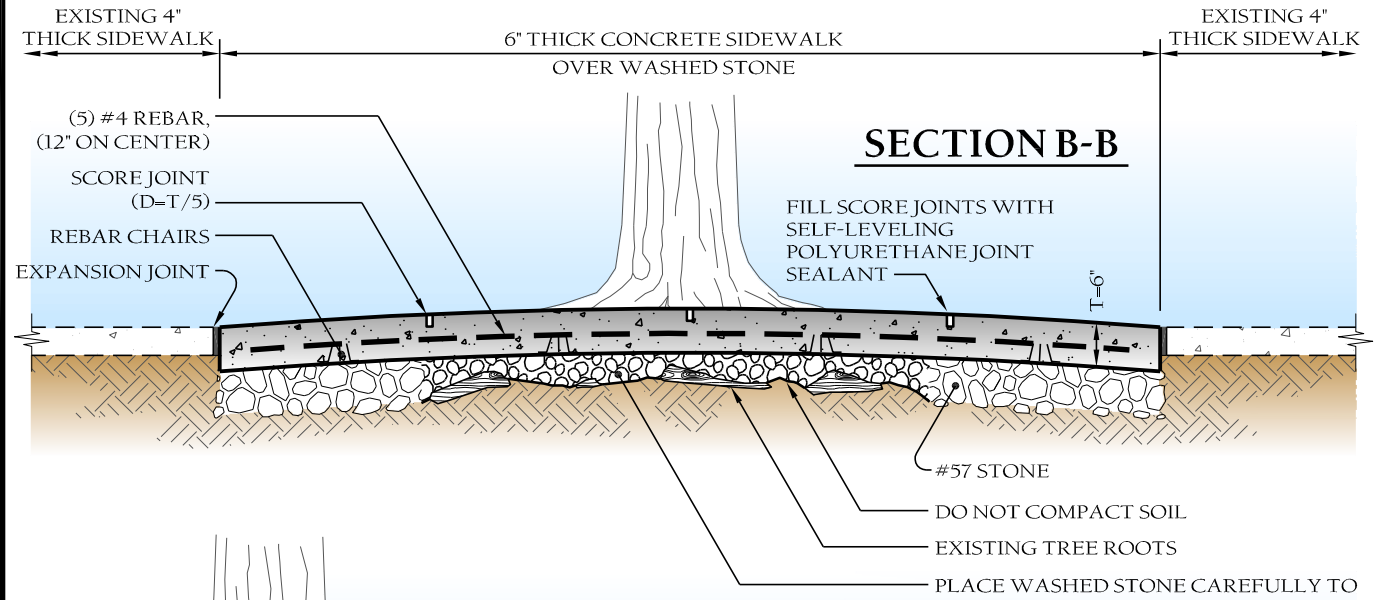
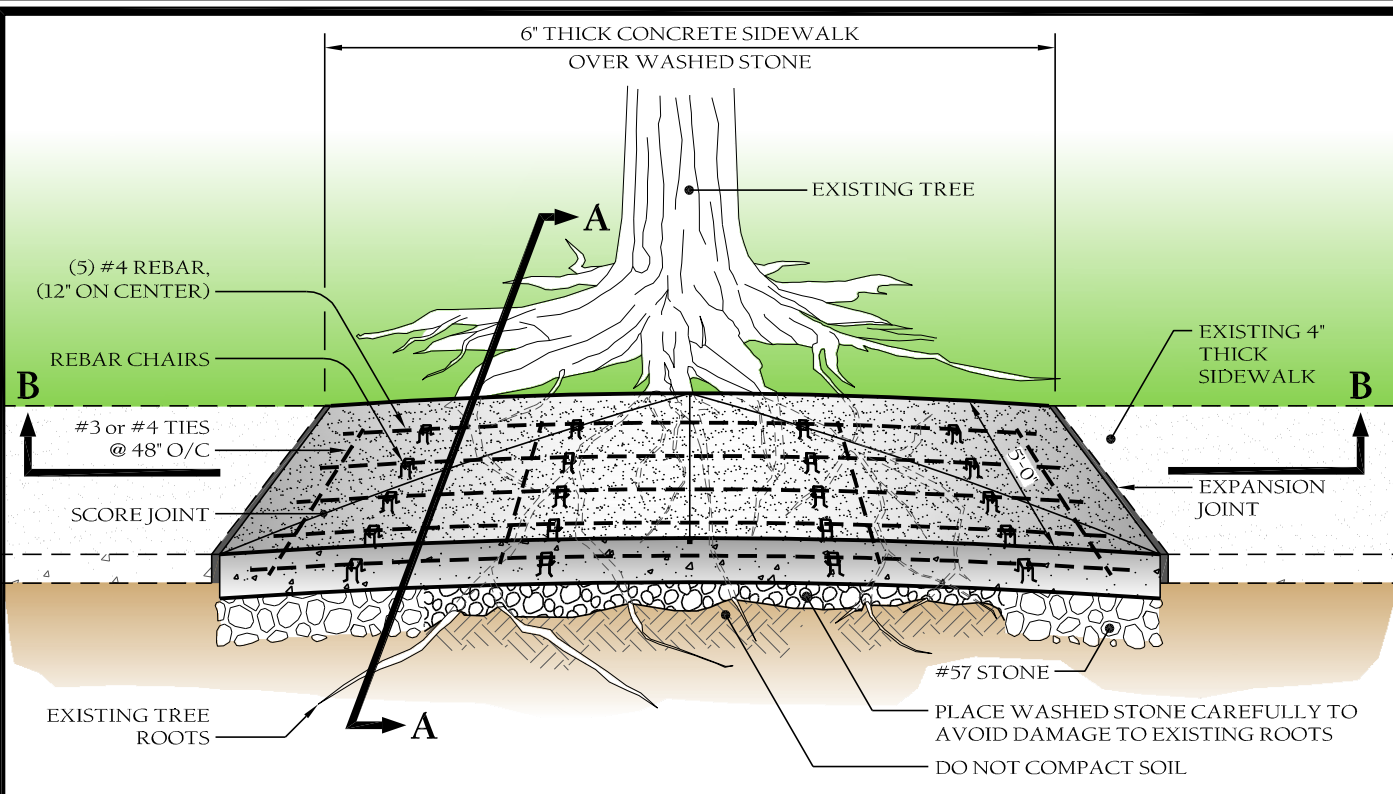

TOWN of WAKE FOREST, NC
Manual of Specifications, Standards and Design

**REINFORCED CONCRETE SIDEWALK
(BRIDGING TREE ROOTS)**

Scale: Not To Scale	Detail #: 8.07
Revision Date: Feb., 2015	Sheet #: 1 of 1

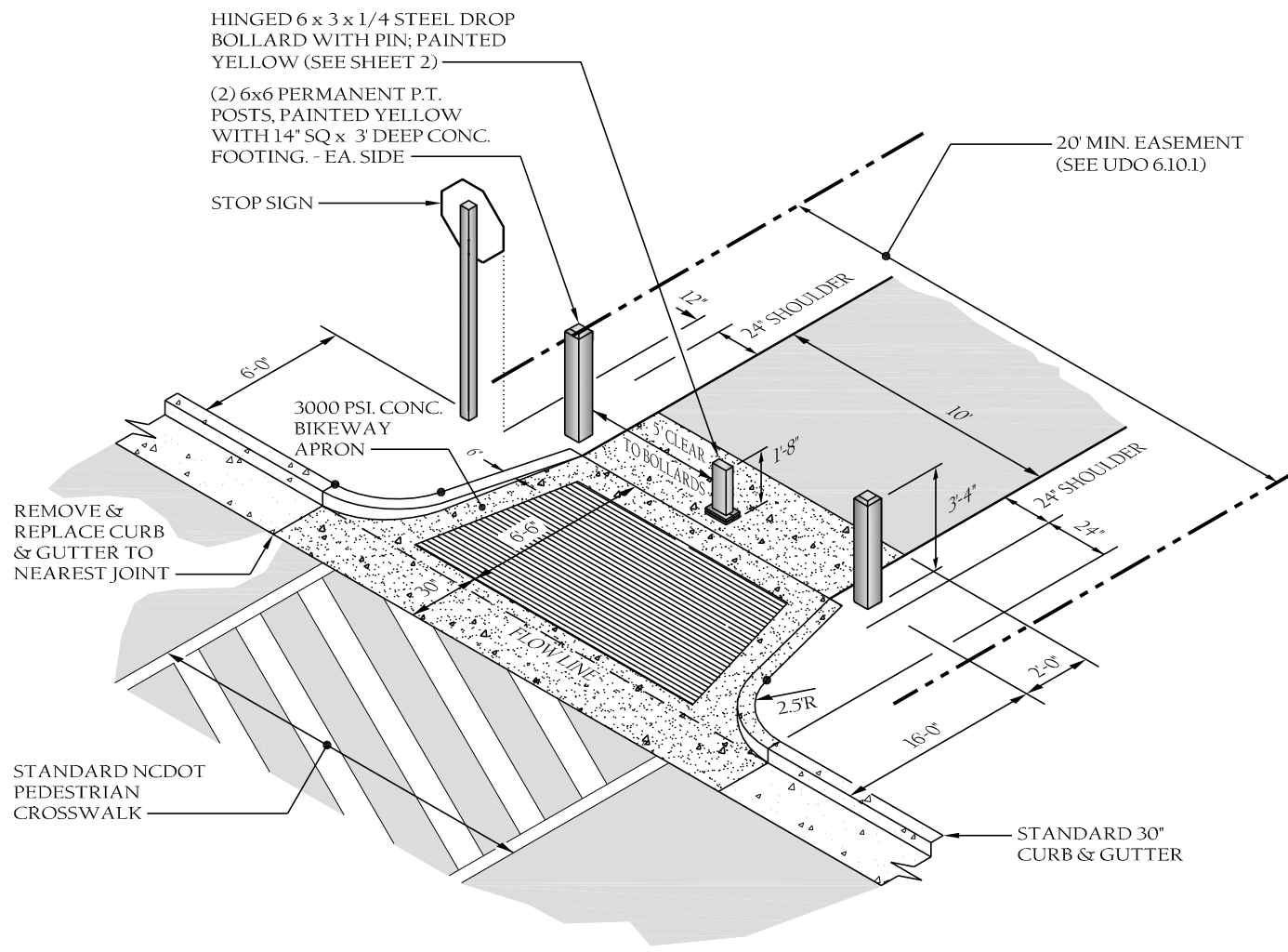

NOTES:

- 1. Steel drop bollard may be constructed as shown on sheet 2 or a Traffic Guard Low Profile Heavy Duty Hinged Bollard may be used (Model LPHDHB) installed per manufacturer's directions.



TOWN of WAKE FOREST, NC
 Manual of Specifications, Standards and Design

MULTI-USE PATH DETAIL
STREET TIE-IN

Scale: Not To Scale	Detail #: 8.08
Revision Date: Feb., 2015	Sheet #: 1 of 1

LONGITUDINAL SECTION

EXISTING PORTLAND CEMENT CONCRETE TO PROPOSED ASPHALT CEMENT CONCRETE

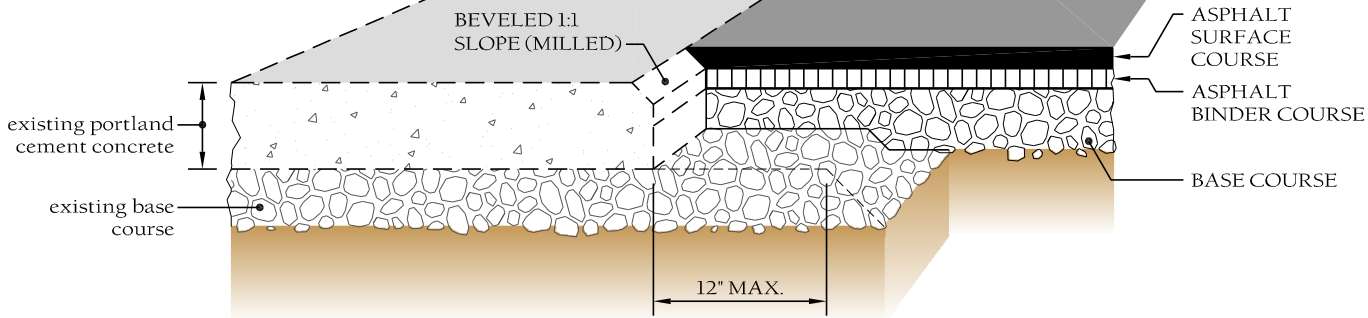

LONGITUDINAL SECTION

EXISTING ASPHALT CEMENT CONCRETE TO PROPOSED ASPHALT CEMENT CONCRETE

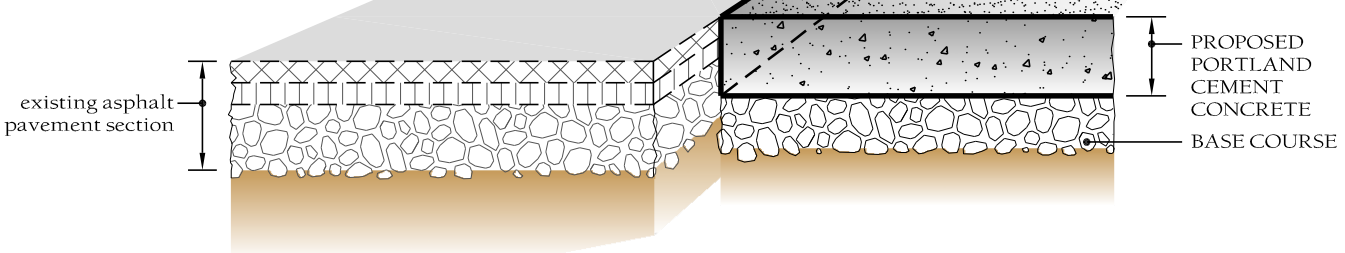

LONGITUDINAL OR TRANSVERSE SECTION

EXISTING PORTLAND CEMENT CONCRETE TO PROPOSED PORTLAND CEMENT CONCRETE

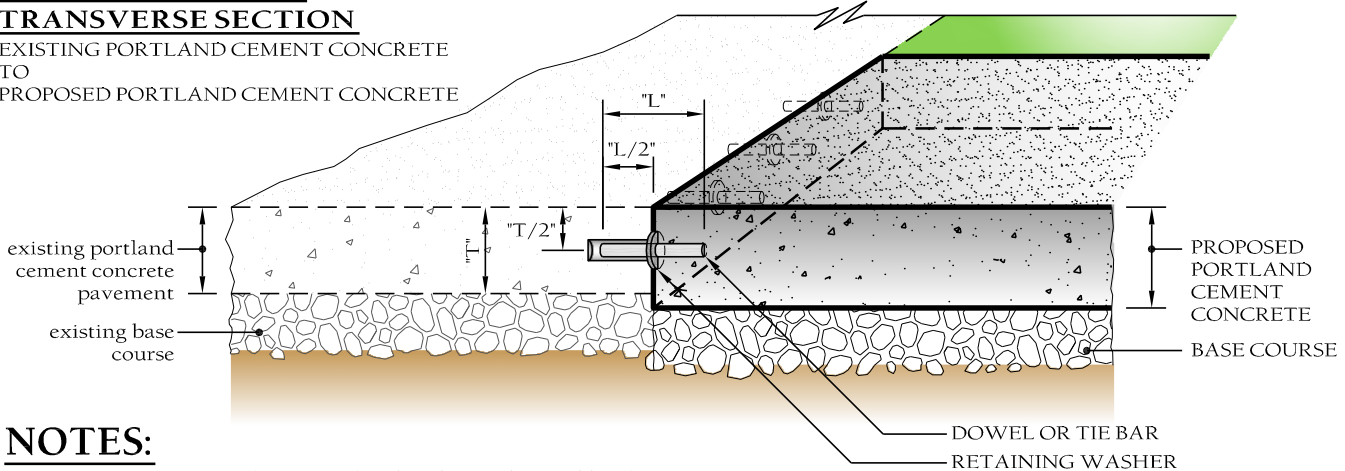

NOTES:

1. Joint pavements as shown on this detail or as directed by the Town's Engineer.
2. Place tie bars (deformed steel bars) along the longitudinal joints at 30" on center. Place dowel bars (smooth steel bars) along the traverse joints at 12" on center. The placement and/or spacing of tie or dowel bars may be modified by the plans of the Town's Engineer. Measure the holes, to accept these bars, the O.D. of the bar plus 1/8" in diameter and 1/2 the length of the bar plus 1" unless otherwise specified by the manufacturer of the adhesive. Use retaining washers (nylon, plastic or composite) on all bars to hold the adhesive material in place. The retaining washers shall be: I.D. = bar O.D., O.D. = hole I.D. + 1/4" min., thickness = 1/16" min. See NCDOT standard drawing 700.01 for bar sizes and other joint related information. Provide adhesive bonding material specified by Section 1081 of the 2012 NCDOT Standard Specifications for Type 3 or 3A adhesives.
3. See typical sections for pavement composition and for other specific information.



TOWN of WAKE FOREST, NC
Manual of Specifications, Standards and Design

TYING PROPOSED PAVEMENT TO EXISTING PAVEMENT

Scale: Not To Scale

Detail #: 8.09

Revision Date: Feb., 2015

Sheet #: 1 of 1

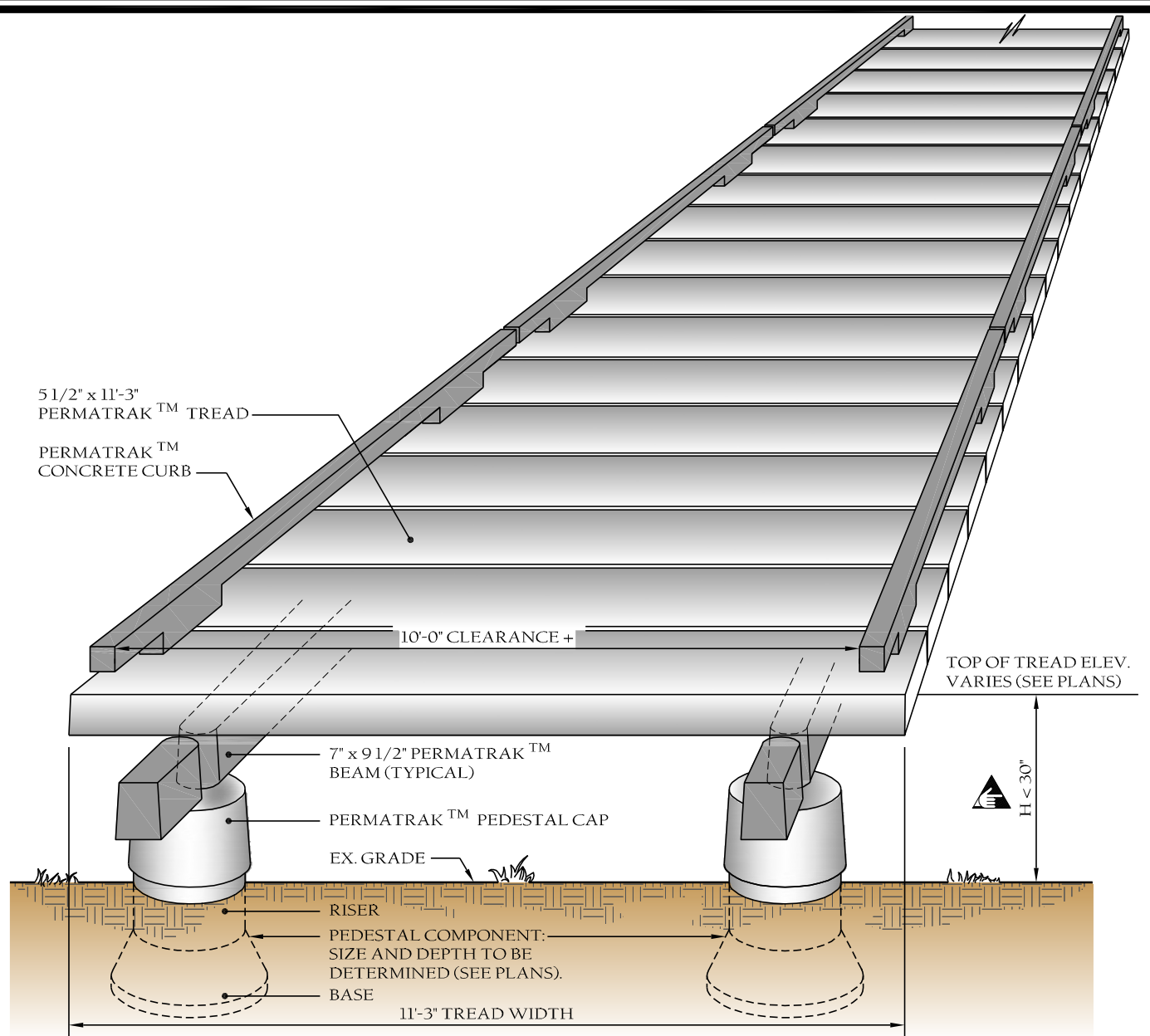

NOTES:

1. PermaTrak foundations may consist of a standard Cap, Riser and Base (as shown on this detail) for shallow bridge clearances. Where wetlands or poor soils are encountered or a greater clearance is necessary requiring the use of piles, the foundation shall consist of pile system comprised of a standard PermaTrak cap placed on top of pilings [Pile type, size and depth to be determined by design engineer]. Coordinate cap/pile connection with manufacturer.
2. PermaTrak boardwalk systems shall be installed per the manufacturer's installation instructions and as shown on the design drawings as approved by the Town's Engineer.
3. Precast abutments either manufactured by PermaTrak or compatible with PermaTrak Beam/Tread must be used at termination ends of boardwalk. Specialized abutment design may be necessary depending on site conditions.
4. Longitudinal beam spans and Base/Riser/Cap spacing shall be determined by analysis and shown on the design drawings.
5. Bases should be set on a prepared subgrade of compacted sand, clean gravel, or concrete per the installation drawings. Bases shall be set level and to the elevation noted on the design drawings. If soft subgrade is encountered, improve as directed by either a Geotechnical Engineer or the project engineer.
6. Precast concrete curbs shall be installed on all elevated boardwalks with a grade separation greater than 4".
7. When the vertical grade separation exceeds 30 inches, hand/guard rails are required (see design manual). In such cases, employ PermaTrak handrail brackets to support/brace handrail posts.
8. All lifting equipment that comes in contact with the precast components should have rubber padding.



TOWN of WAKE FOREST, NC
Manual of Specifications, Standards and Design

PermaTrak™ ELEVATED BOARDWALK
SECTION (HEIGHT < 30")

Scale: Not To Scale	Detail #: 8.10
Revision Date: Feb., 2015	Sheet #: 1 of 2

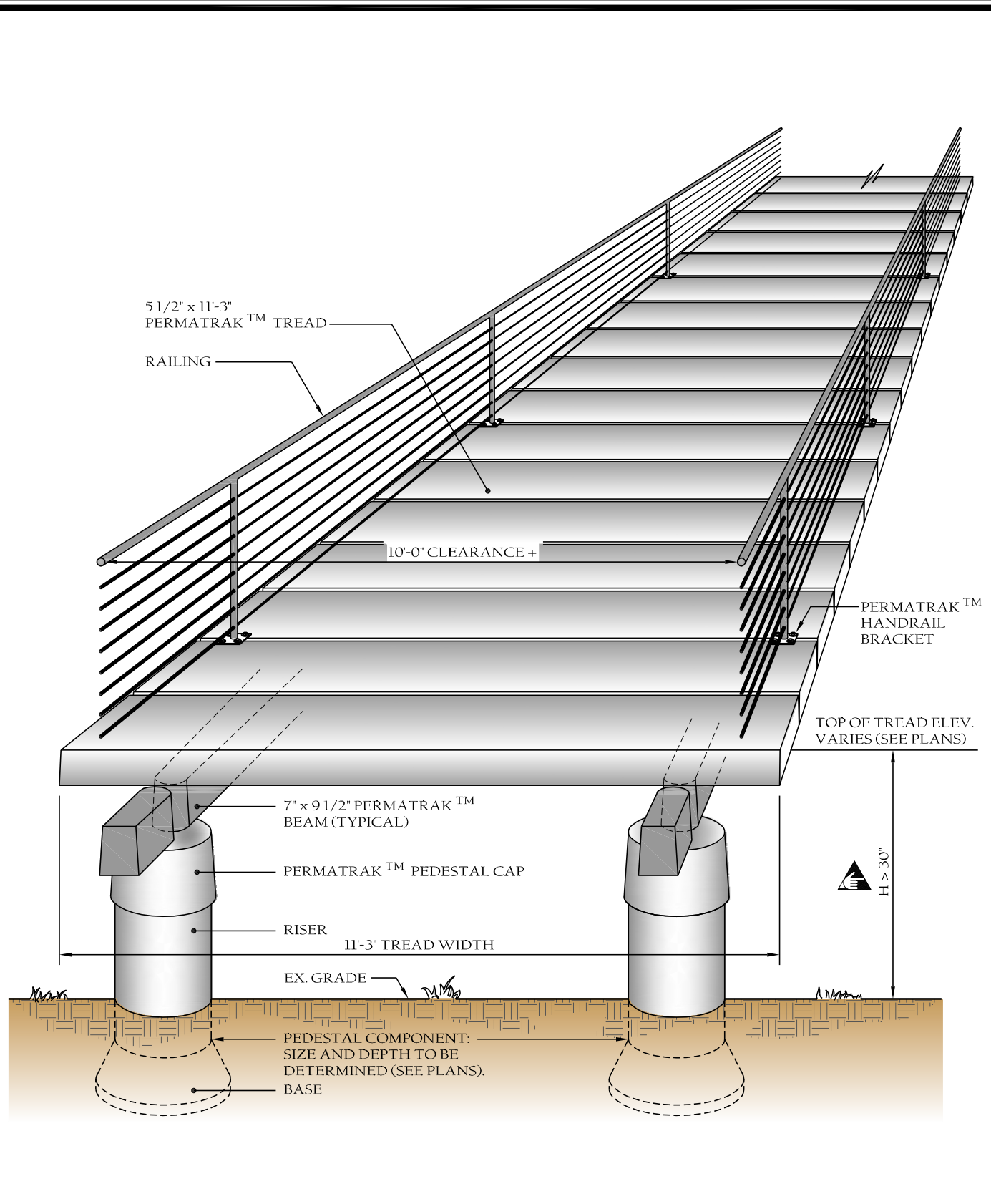

TOWN of WAKE FOREST, NC
 Manual of Specifications, Standards and Design

PermaTrak™ ELEVATED BOARDWALK SECTION (HEIGHT > 30")

Scale: Not To Scale	Detail #: 8.10
Revision Date: Feb., 2015	Sheet #: 2 of 2

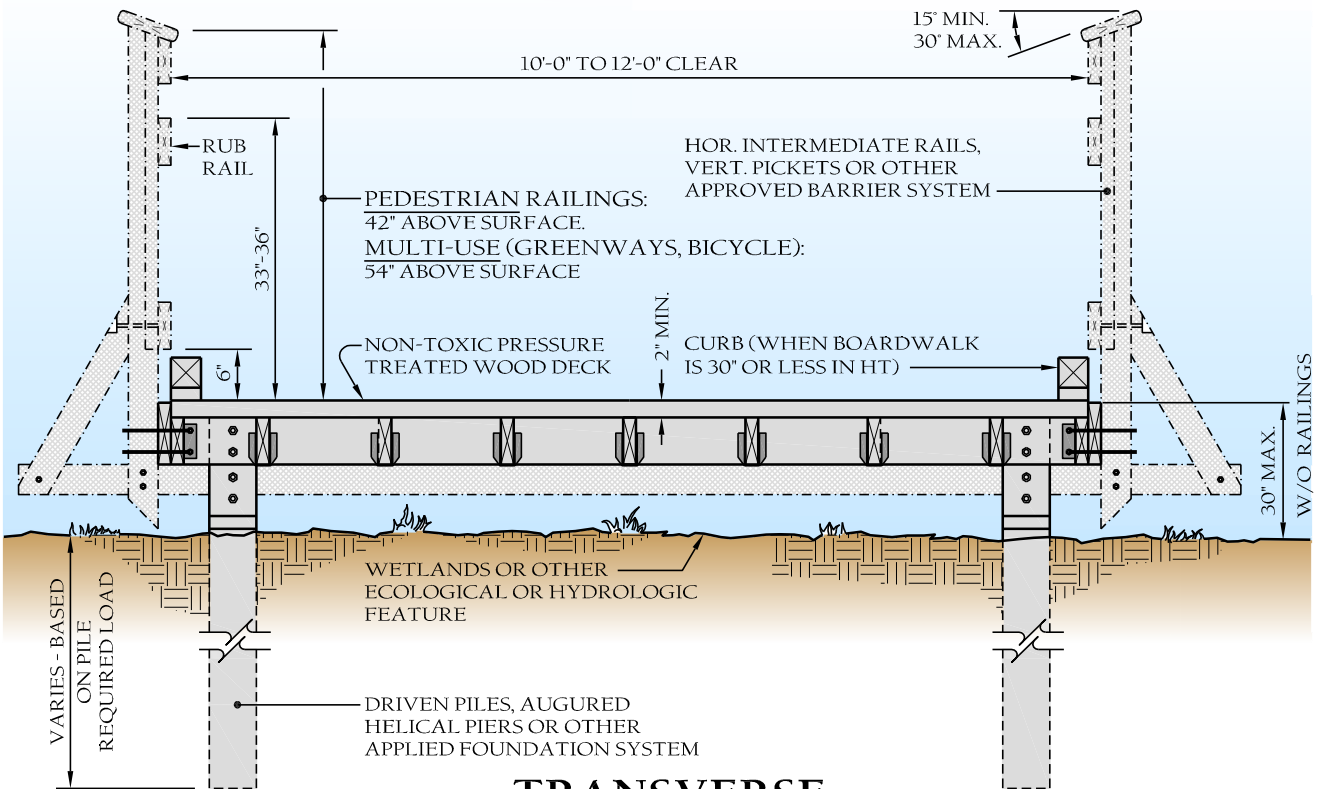
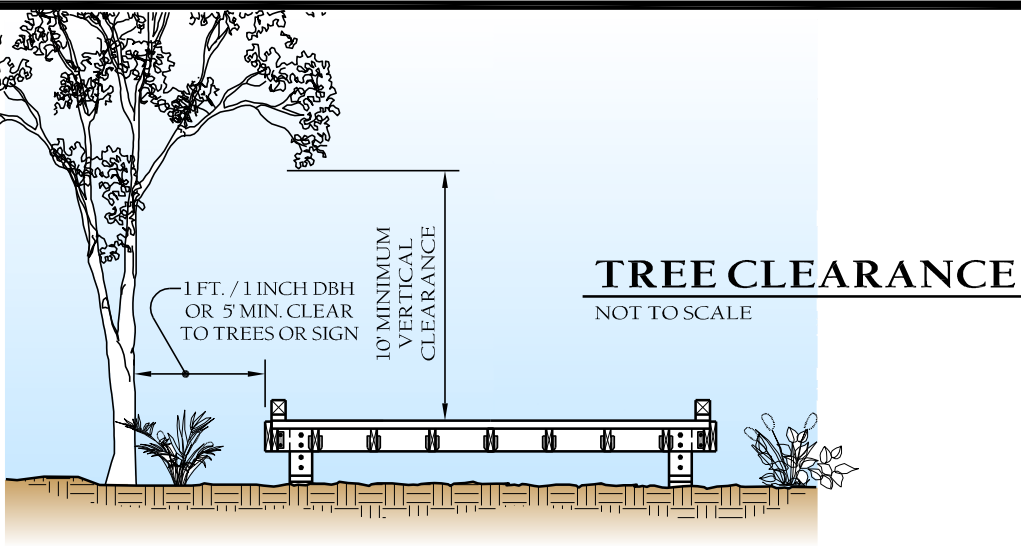

TRANSVERSE BOARDWALK SECTION

NOT TO SCALE

NOTES:

1. Refer to the *Town of Wake Forest Greenway Boardwalk and Foot Bridge Design manual* for design criteria.
2. When height of boardwalk exceeds 30", designer to evaluate need for lateral bracing.



TOWN of WAKE FOREST

TOWN of WAKE FOREST, NC
Manual of Specifications, Standards and Design

TIMBER BOARDWALK / FOOT BRIDGE
CONCEPT OPTION

Scale:
Not To Scale

Detail #:
8.11

Revision Date:
Feb., 2015

Sheet #:
1 of 1

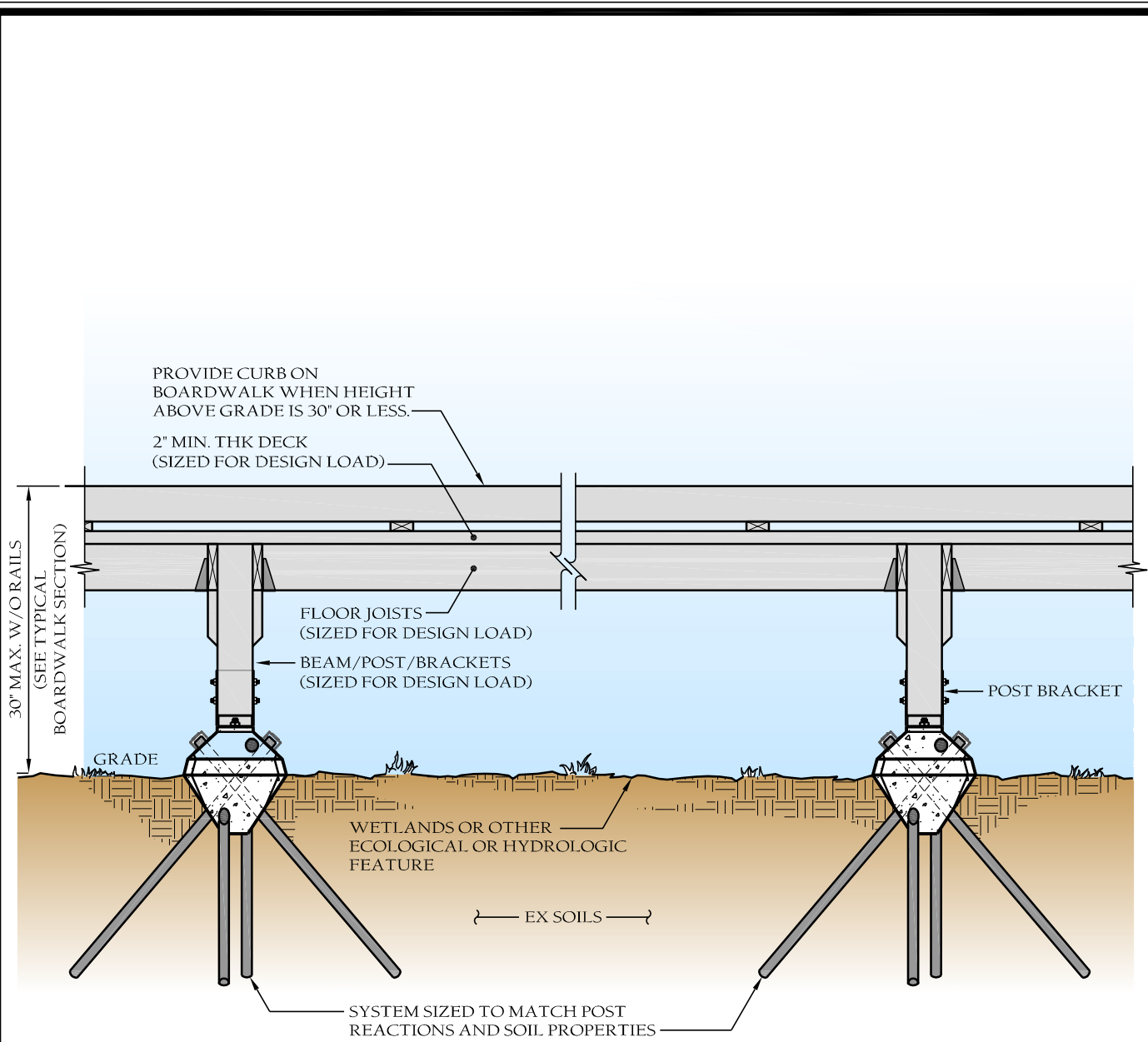

LONGITUDINAL BOARDWALK SECTION
SHOWING ALT. FOUNDATION SYSTEM
SUPPORTING TIMBER POSTS

NOTES:

1. Refer to the *Town of Wake Forest Greenway Boardwalk and Foot Bridge Design manual* for design criteria.
2. When height of boardwalk exceeds 30", designer to evaluate need for lateral bracing.



TOWN of WAKE FOREST, NC
 Manual of Specifications, Standards and Design

ALT. BOARDWALK / FOOT BRIDGE
FOUNDATION SYSTEM

Scale:
Not To Scale

Detail #:
8.12

Revision Date:
Feb., 2015

Sheet #:
1 of 1

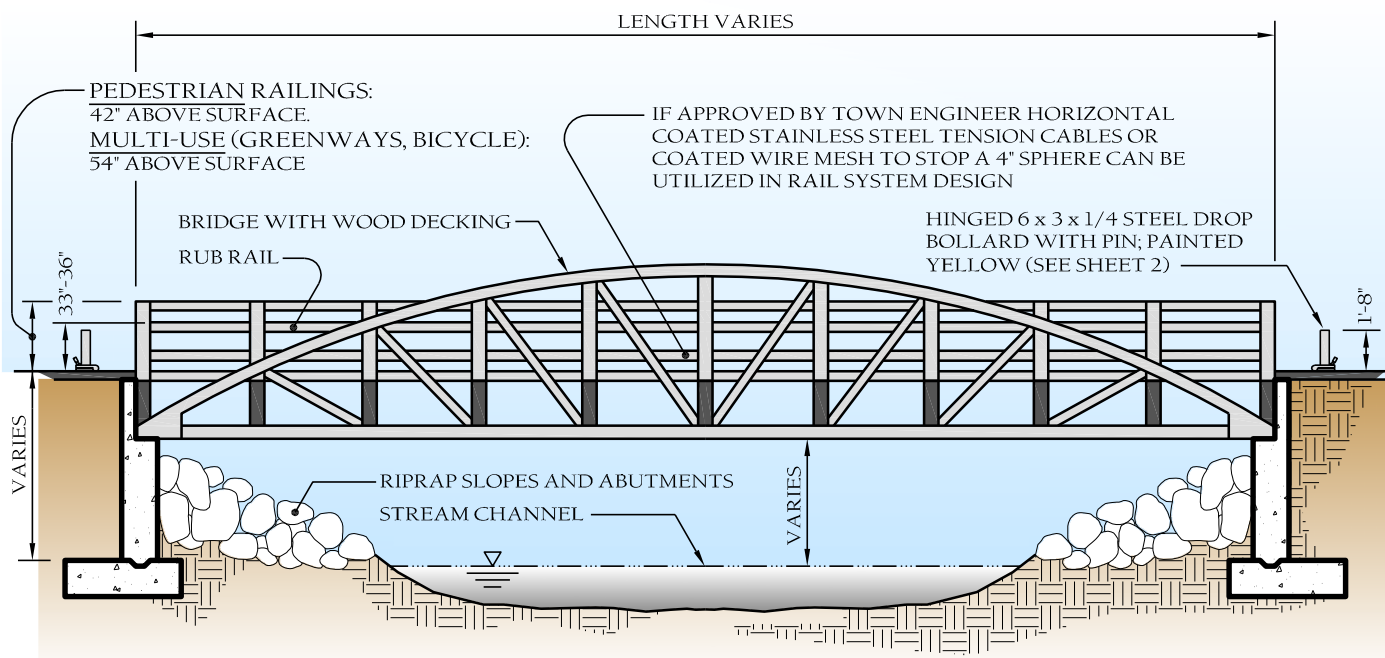

NOTES:

1. Refer to the *Town of Wake Forest Greenway Boardwalk and Foot Bridge Design manual* for design criteria.



TOWN of WAKE FOREST, NC
Manual of Specifications, Standards and Design

**MULTI-USE PATH DETAIL - BOWSTRING
PRATT HALF THROUGH TRUSS OPTION**

Scale:
Not To Scale
Revision Date:
Feb., 2015

Detail #:
8.13
Sheet #:
1 of 1

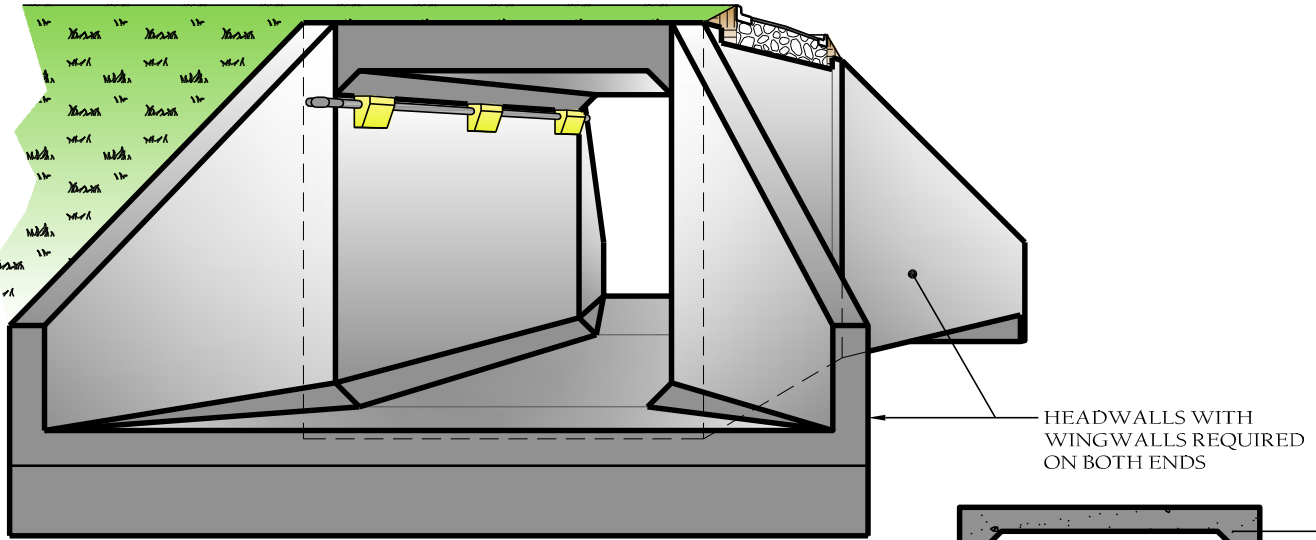

FRONT VIEW
(ISOMETRIC)

HEADWALLS WITH WINGWALLS REQUIRED ON BOTH ENDS

LITHONIA WALL-PAK TWPI50F WITH TWPWG WIRE GUARD OR APPROVED EQUAL

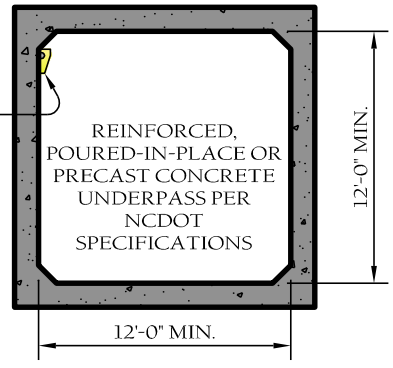

REINFORCED, POURED-IN-PLACE OR PRECAST CONCRETE UNDERPASS PER NCDOT SPECIFICATIONS

12'-0" MIN.

12'-0" MIN.

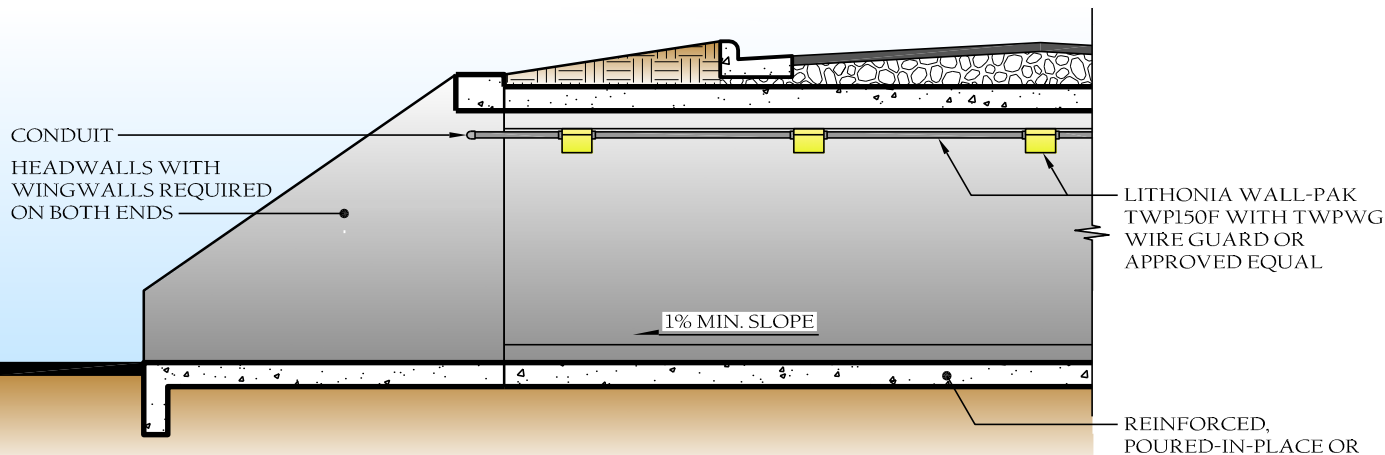

CONDUIT
HEADWALLS WITH WINGWALLS REQUIRED ON BOTH ENDS

1% MIN. SLOPE

LITHONIA WALL-PAK TWPI50F WITH TWPWG WIRE GUARD OR APPROVED EQUAL

REINFORCED, POURED-IN-PLACE OR PRECAST CONCRETE UNDERPASS PER NCDOT SPECIFICATIONS

PARTIAL LONGITUDINAL SECTION

NOTES:

1. Sealing of fixtures to be designed in accordance with IES standards
2. Appropriate signage to be placed at entrance to indicate narrowing trail width if applicable and limited vertical clearance.



TOWN of WAKE FOREST, NC
Manual of Specifications, Standards and Design

PEDESTRIAN / BICYCLE UNDERPASS

Scale: Not To Scale	Detail #: 8.14
Revision Date: Feb., 2015	Sheet #: 1 of 1

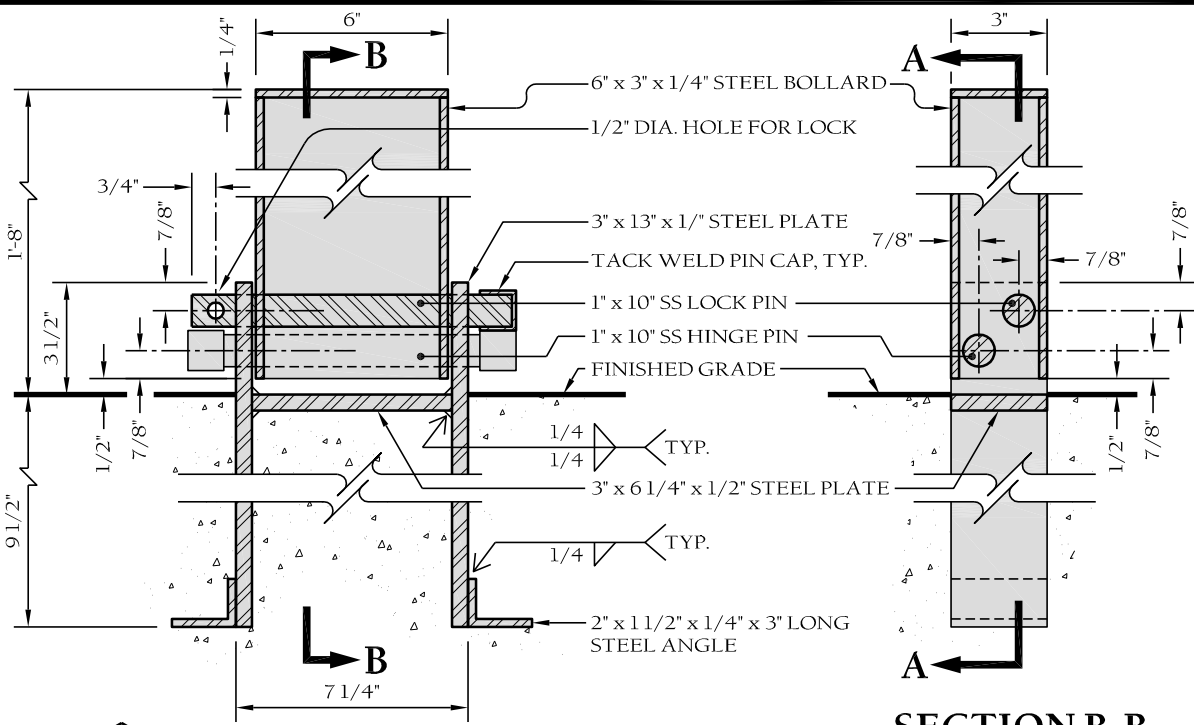

SECTION A-A

SECTION B-B

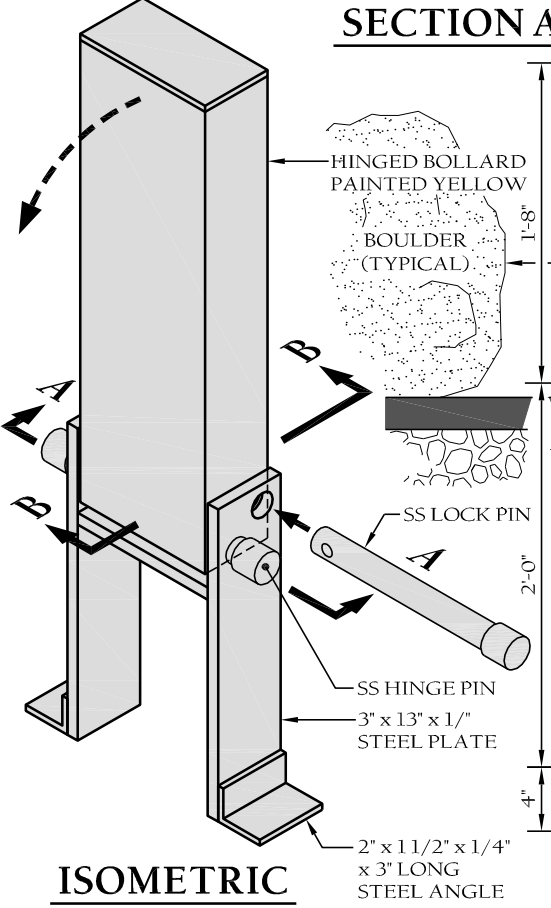

ISOMETRIC

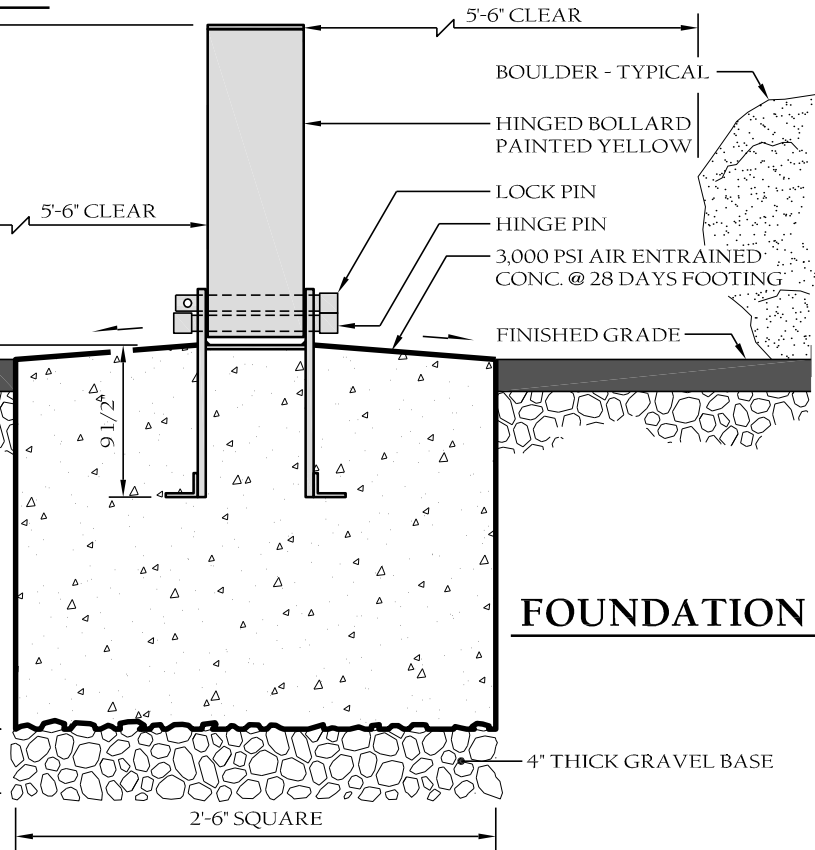

HINGED BOLLARD DETAIL



TOWN of WAKE FOREST, NC
Manual of Specifications, Standards and Design

LOW PROFILE HEAVY DUTY HINGED BOLLARD DETAIL

Scale: Not To Scale	Detail #: 8.15
Revision Date: May, 2014	Sheet #: 1 of 1

THREE RACKS

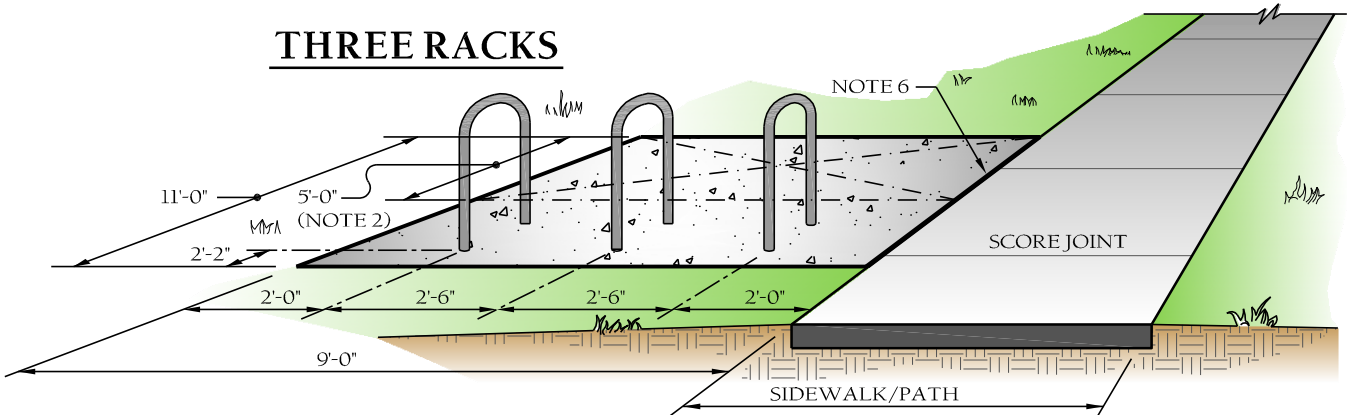

ONE RACK

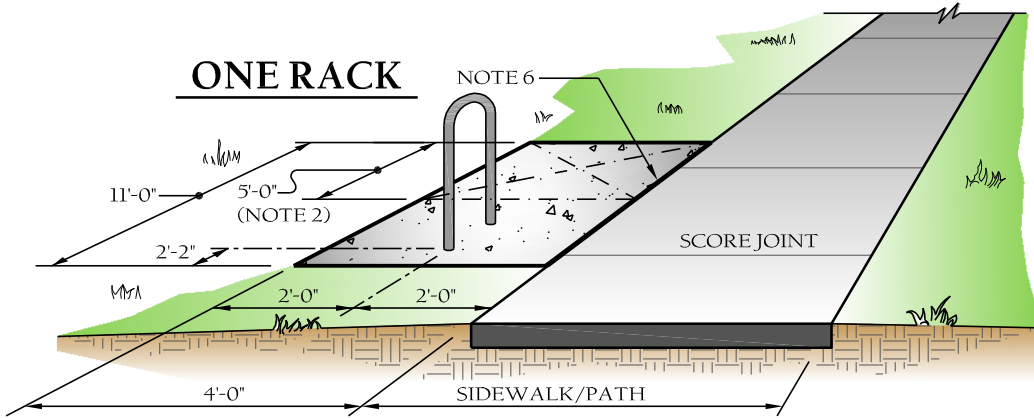

OPTION 1:
PARALLEL TO SIDEWALK
 (PREFERRED)

NOTES:

1. Parking pad to be min. 6" thick, 3,000 psi concrete. Size as shown. (Pad to be min. 4X6 for single rack and 2'-6" additional width per rack, with racks spaced 2'-6" o/c if more than one.)
2. A 5'-0" wide unobstructed maneuvering area is required behind racks when orientated parallel to a sidewalk as shown; requires a min. 4'-0" x 11'-0" pad.
3. Racks shall be flange mounted and shall have black polyester powder coat. Other placements shall meet minimum size requirements.
4. Bicycle parking shall not encroach on accessible paths.
5. Designated placement within parking lots may also be acceptable.
6. Provide expansion joint where concrete pad abuts concrete sidewalk, pad or pathway.
7. Other bike rack designs will be considered upon approval of the Town of Wake Forest Planning Department.

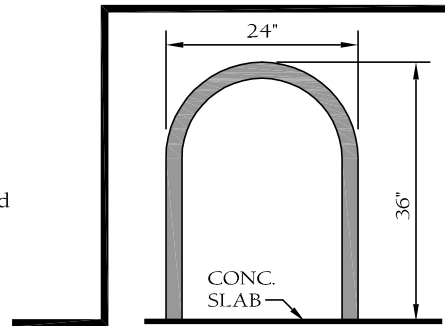

INVERTED "U" RACKS



TOWN of WAKE FOREST

TOWN of WAKE FOREST, NC
 Manual of Specifications, Standards and Design

BICYCLE PARKING
PARALLEL TO SIDEWALK

Scale: Not To Scale	Detail #: 8.16
Revision Date: Feb., 2015	Sheet #: 1 of 2

THREE RACKS

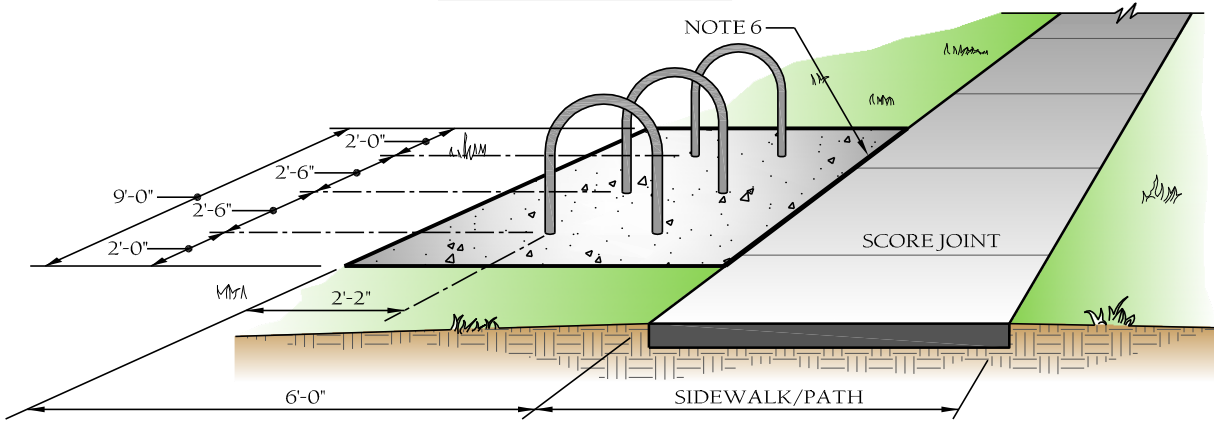

ONE RACK

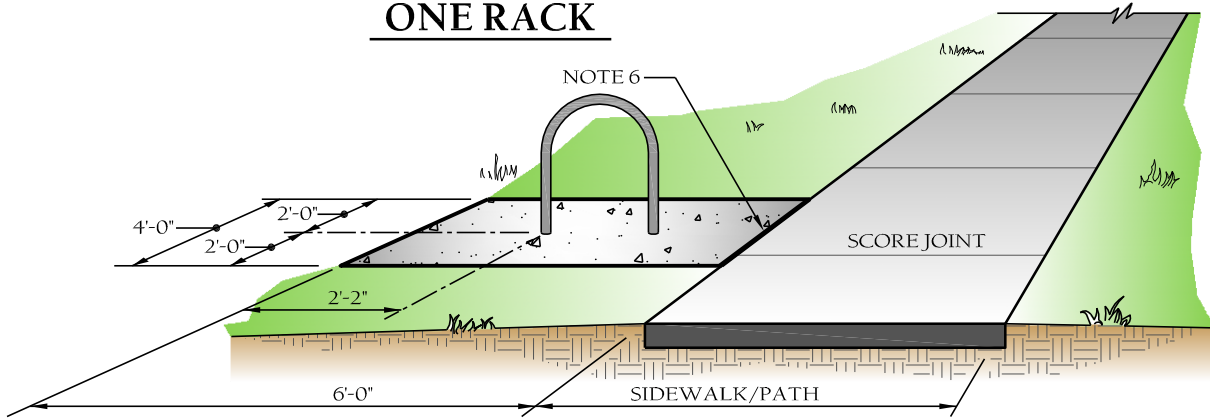

OPTION 2:
PERPENDICULAR TO SIDEWALK
 (OPTIONAL)



TOWN of
 WAKE FOREST

TOWN of WAKE FOREST, NC

Manual of Specifications, Standards and Design

BICYCLE PARKING

PERPENDICULAR TO SIDEWALK

Scale:
 Not To Scale

Detail #:
8.16

Revision Date:
 Feb., 2015

Sheet #:
 2 of 2

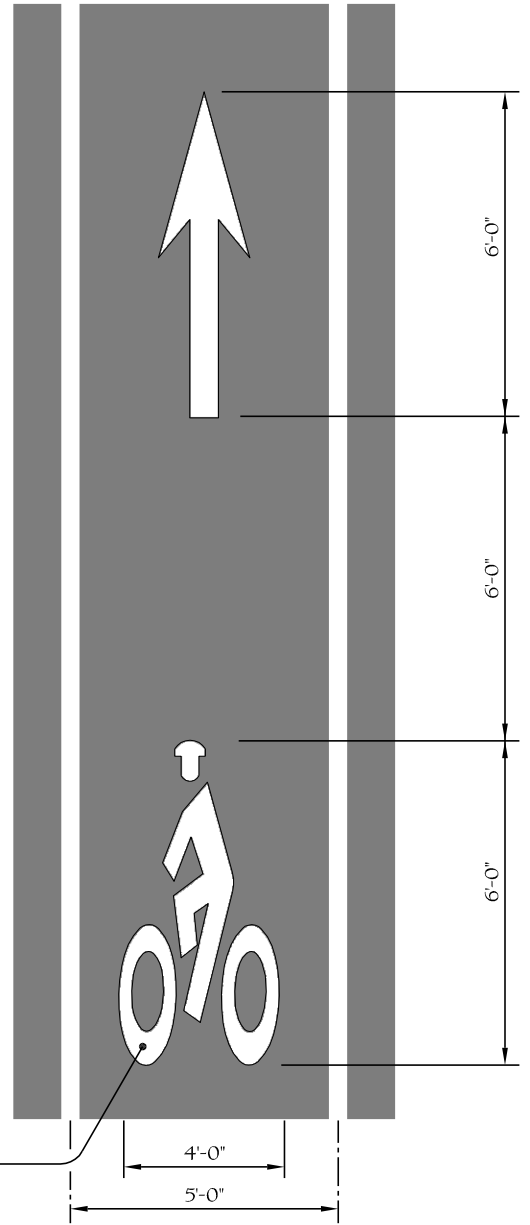
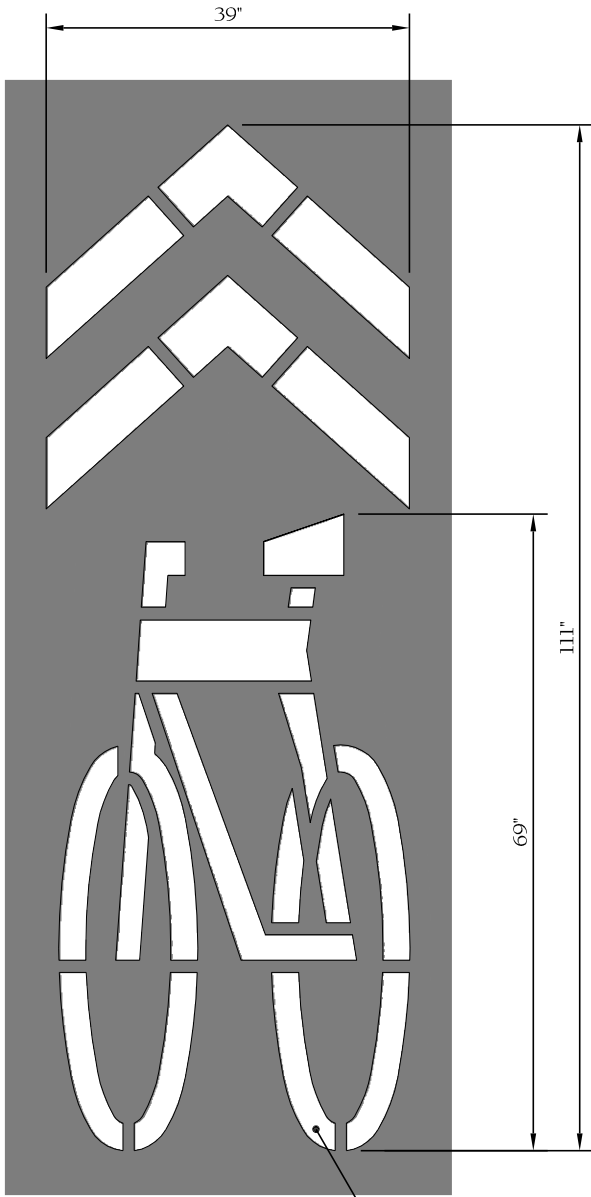

WHITE REFLECTORIZED
PAINT OR THERMOPLASTIC
MARKINGS

**SHARED BIKE LANE
MARKINGS**
"SHARROW"

**BIKE LANE SYMBOL
MARKINGS**



TOWN of
WAKE FOREST

TOWN of WAKE FOREST, NC
Manual of Specifications, Standards and Design

**BIKE LANE
SYMBOL MARKINGS**

Scale:
Not To Scale

Detail #:
8.17

Revision Date:
Feb., 2015

Sheet #:
1 of 1

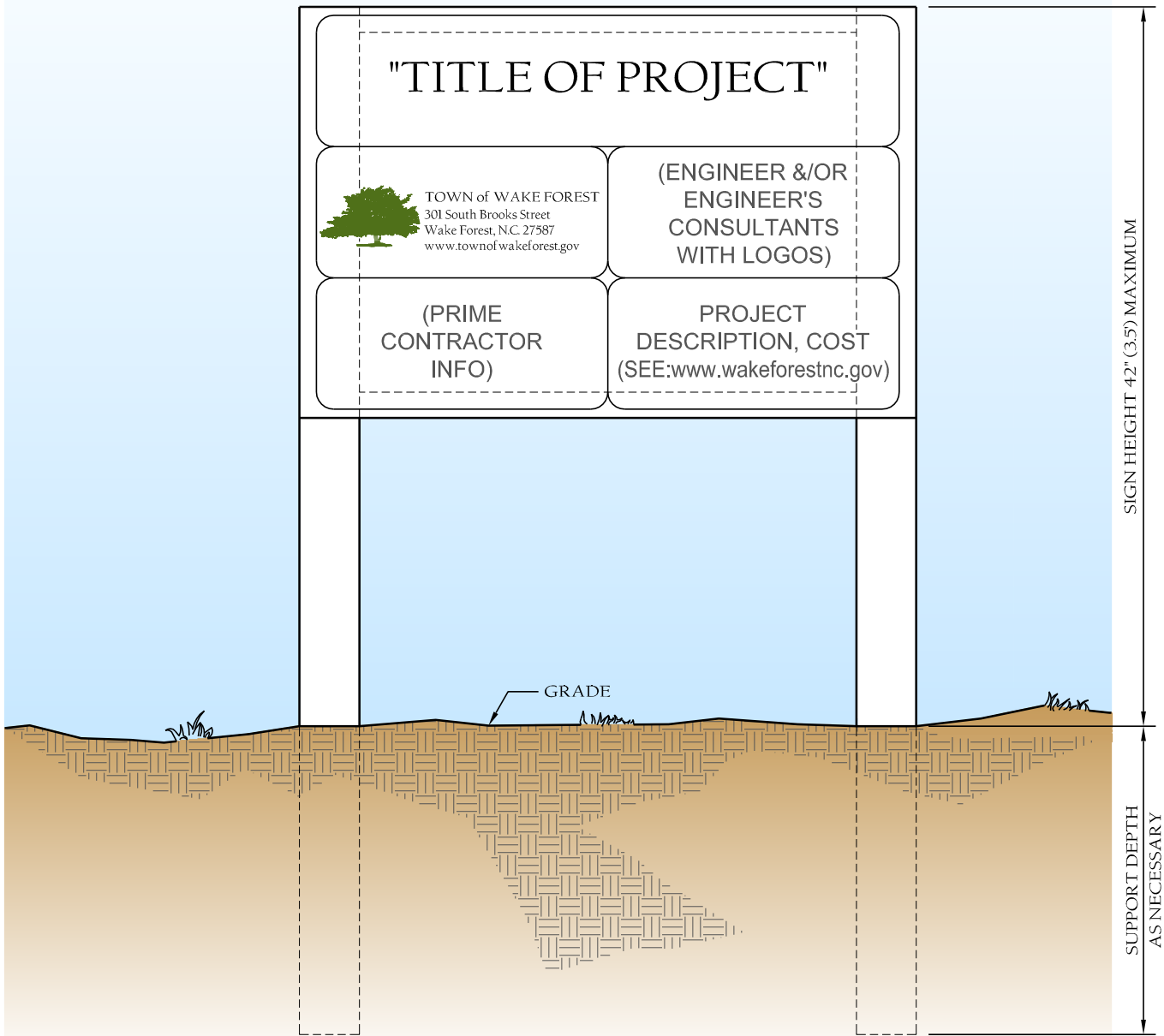

NOTES:

1. Total sign area = 32 S.F. per side (Maximum).



TOWN of WAKE FOREST, NC
Manual of Specifications, Standards and Design

PROJECT IDENTIFICATION SIGN
for TOWN FUNDED CAPITAL PROJECTS

Scale:
Not To Scale

Detail #:
8.18

Revision Date:
Feb., 2015

Sheet #:
1 of 1

PAVEMENT SECTION MATRIX

UDO Street Type <small>(See UDO paragraph 6.7.2 "Town Street Classifications" for R/W & street cross-section requirements)</small>	ADT <small>(vpd)</small>	Minimum Pavement Section					
		SuperPave Asphalt Thickness			Aggregate Base <small>(ABC)</small>	Geogrid ¹	Curb & Gutter ²
		Riding Surface <small>(S-9.5B)</small>	Intermediate Course <small>(I-19.0B)</small>	Base Course <small>(B-25.0)</small>			
Urban Boulevard <small>(UDO 6.7.2B)</small>	25k to 55k	As Designed	As Designed	As Designed	8	Note 1	Type 3
Avenue <small>(UDO 6.7.2C)</small>	15k to 30k	As Designed	As Designed	As Designed	5	-	Type 2
Commercial Street <small>(UDO 6.7.2D)</small>	10k to 18k	2	-	4	5	-	Type 1
Large Residential Street <small>(UDO 6.7.2E)</small>	2.5k to 15k	2	-	4	5	-	Type 2 or 4
Residential Yield Street <small>(UDO 6.7.2F)</small>	0 to 1k	2	-	-	8	Note 1	Type 2 or 4
Lane <small>(UDO 6.7.2G)</small>	0 to 3k	2	-	-	8	Note 1	Type 1 or 5
Alley <small>(UDO 6.7.2H)</small>	N/A	2	-	-	6	-	N/A
Industrial Access ³	N/A	As Designed	As Designed	As Designed	8	Note 1	Type 3

1. For all street classifications within the street right-of-way, the aggregate base thickness may be reduced by 2 inches if an approved Geogrid is installed between the compacted subgrade and the aggregate base. Geogrid to be *Tensor BX1100 (SS-2)*, an approved equal, or as otherwise specified by a NC Licensed PE (Geotechnical Engineer).
2. Curb & Gutter Types (see Standard Detail 9.02):
 - Type 1- 30-inch Standard Curb & Gutter.
 - Type 2- 30-inch Standard Curb & Gutter or approved alternate.
 - Type 3- 30-inch Standard Curb & Gutter with 5 inches of ABC below curb and extending a minimum of 6 inches beyond the back of the curb or approved alternate.
 - Type 4- 30-inch Valley Curb.
 - Type 5- LID or Swale.
3. Right-of-way and street section to be as required by Town Engineer.
4. Street pavement sections must be designed using the procedures outlined in the UDO, Section 3, Street and Subdivision Design, paragraph 3.3 Pavement Design Methods except that individual elements shall not be less than shown in the above table.
5. See UDO Section 6, Infrastructure Standards, paragraphs 6.5.3 Pedestrian/Bicycle Connections, 6.7.2 Town Street Classification, 6.8 Sidewalk and Other Pedestrian Facilities and 6.9 Bikeway Facilities for sidewalk and bikeway requirements.



TOWN of WAKE FOREST, NC

Manual of Specifications, Standards and Design

PAVEMENTS SECTION MATRIX

Scale: Not To Scale	Detail #: 9.01
Revision Date: Feb., 2015	Sheet #: 1 of 3

Notes:

1. *Sidewalk and curb to be 3000 psi at 28 days air entrained concrete. Sidewalk to be scored every 5 ft with 1/2" expansion joints at 30 ft intervals. Provide non-slip finish. Concrete sidewalks to be 4" except thickness to increase to 6" at all driveway crossings and for a distance 5' either side of the driveway. Place 1/2" expansion joints at junction of 4" and 6" sidewalks.*
2. *Maximum grades and "K" valves for streets shall follow NCDOT guidelines for the Piedmont area (rolling topography). See Table 9.03.*
3. *All pavement thickness' shall generally be confirmed by a geotechnical investigation and report. However, if a developer wishes, he may design residential streets using a subgrade CBR one standard deviation to the left of the average of all CBR's determined by geotechnical reports thus far. If, in the opinion of the Town's representative, soils appear weaker or have inherent problems such as a high mica content, the services of a geotechnical engineer shall be required in any case for the design of pavements.*
4. *Electric service will not go in until street section is graded at final and approved.*
5. *The Town Engineer shall require a 1" overlay over any segment of street in which there are 3 or more trench failures, utility cuts, egregious imperfections or patches per 800 foot of street. If final surface is already placed, it must be milled down so as not to encroach into the gutter pan. A trench failure shall be defined as a depression of 1/2" or greater at the deepest point over a trench width. Extent of length of resurfacing shall be as determined by the Town's Engineer.*
6. *Time limits for completion of improvement: Refer to UDO Section 6.38.*



TOWN of
WAKE FOREST

TOWN of WAKE FOREST, NC
Manual of Specifications, Standards and Design

PAVEMENTS SECTION
MATRIX

Scale:
Not To Scale

Detail #:
9.01

Revision Date:
Feb., 2015

Sheet #:
2 of 3

Concrete Testing Requirements:

Initial Test

The initial test (from first ready-mix truck) is to be taken after the second yard is dispatched from the mixer and is to consist of the following:

1. One slump test
2. Pull, prepare and store 3 cylinders on-site for 24 hours.
3. Temperature

Subsequent Tests

After the above tests are pulled from the initial truck, every 5th truck thereafter is to be tested in the same manner as noted above.

Asphalt Testing Requirements:

Compaction: Testing for asphalt density is to follow NCDOT "Standard Specifications for Roads and Structures", Section 609-7 "Field Compaction Quality Control" and Section 609-9, "Quality Assurance" latest revision.

Thickness: The minimum frequency of coring for thickness testing shall be on the basis of test sections consisting of not more than 1500 linear feet of lay down width, exclusive of intersections and irregular areas. The test sample is to be a 6-inch cored sample. The sample is to be numbered and logged for identification purposes.

Contractor's Quality Control System:

Follow NCDOT "Standard Specifications for Roads and Structures", Section 609-4 "Contractor's Quality Control Personnel Requirements" and Section 609-5, "Contractor's Quality Control Field Laboratory Requirements," latest revision.

Mixture and Job Mix Formula Adjustments:

Follow NCDOT "Standard Specifications for Roads and Structures", Section 609-3, "Field Verification of Mixture and Job Mix Formula Adjustments", latest revision.

General:

All other applicable sections of Section 609 of the NCDOT "Standard Specifications for Roads and Structures" shall apply relating to Quality Control Plan, mix design, control limits, corrective action, equipment and measurement.

Testing Cost:

Project Owner is responsible for cost of testing.



TOWN of
WAKE FOREST

TOWN of WAKE FOREST, NC

Manual of Specifications, Standards and Design

PAVEMENTS SECTION

MATRIX

Scale:
Not To Scale

Detail #:
9.01

Revision Date:
Feb., 2015

Sheet #:
3 of 3

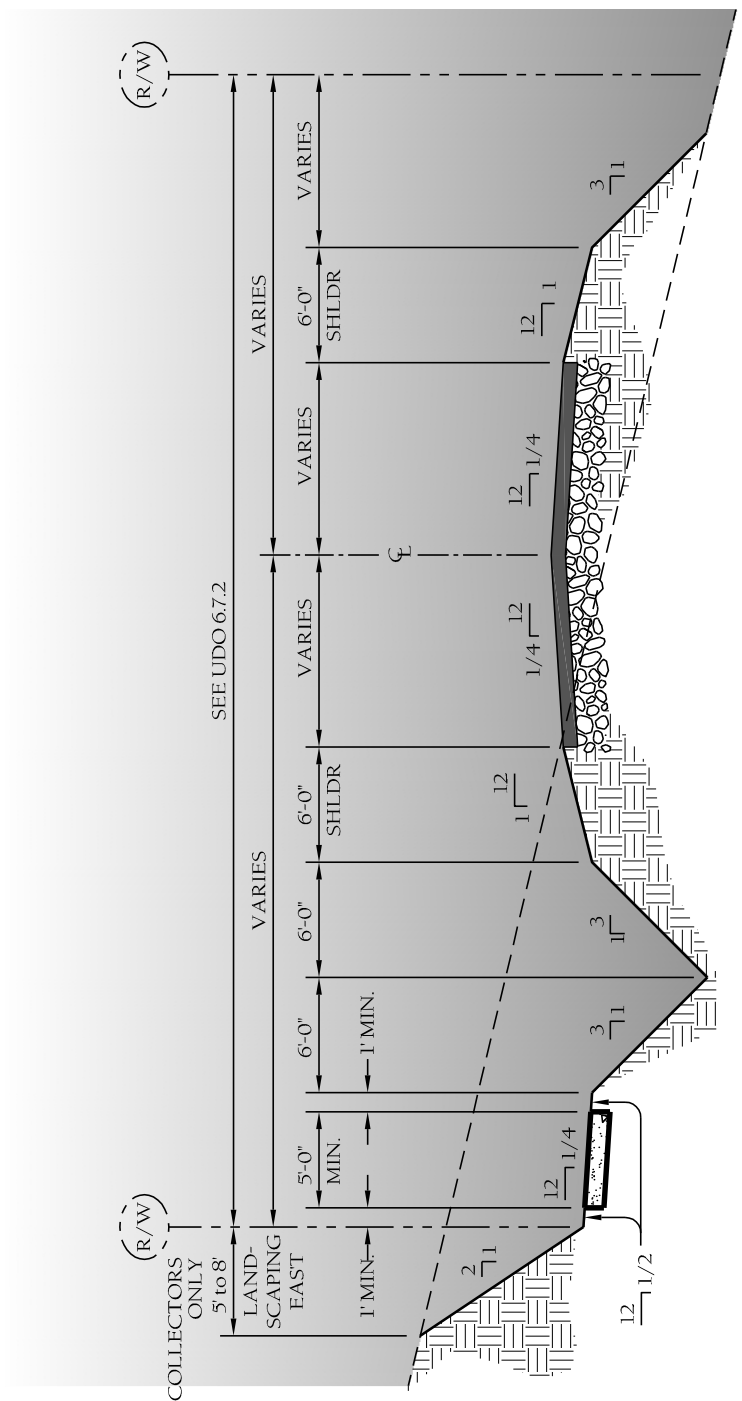

APPLIES TO STREET WHERE SIDE WALK IS REQUIRED



TOWN of WAKE FOREST, NC
Manual of Specifications, Standards and Design

TYPICAL ASYMETRIC X-SECTION WITH SIDEWALK (ON CUT SLOPE)

Scale: Not To Scale	Detail #: 9.01A
Revision Date: Feb., 2015	Sheet #: 1 of 2

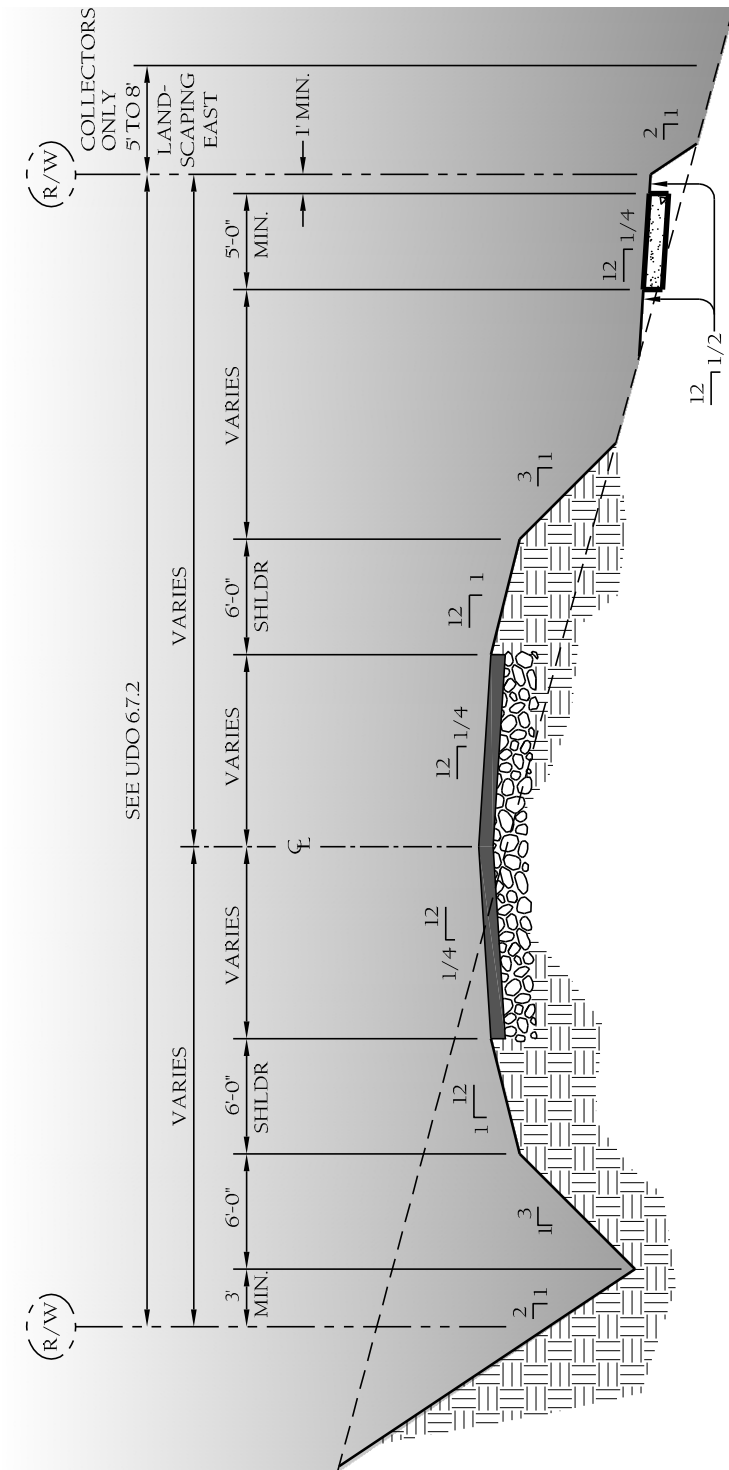

APPLIES TO STREET WHERE SIDE WALK IS REQUIRED



TOWN of WAKE FOREST, NC
Manual of Specifications, Standards and Design

TYPICAL ASYMETRIC X-SECTION WITH SIDEWALK (ON FILL SLOPE)

Scale: Not To Scale	Detail #: 9.01A
Revision Date: Feb., 2015	Sheet #: 2 of 2

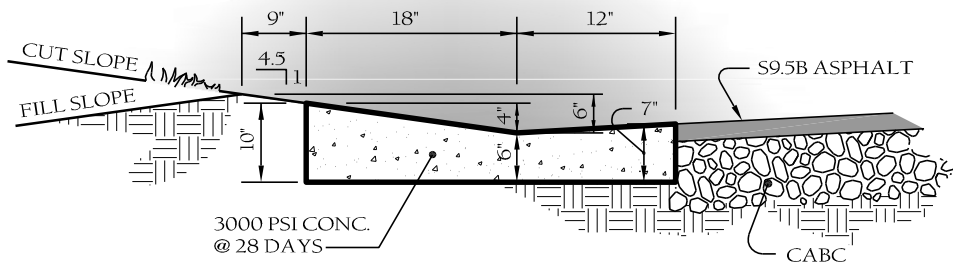

30" VALLEY - STANDARD

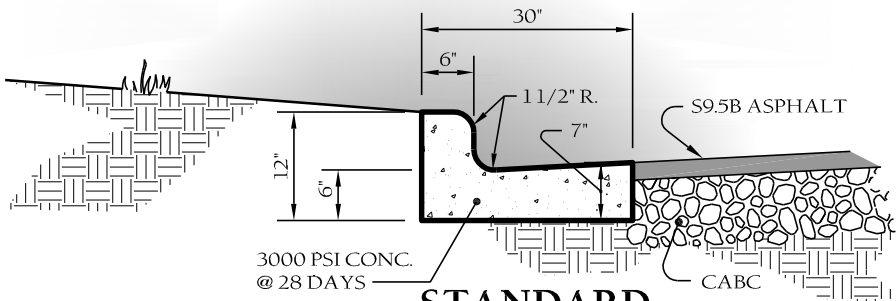

STANDARD

NOTES:

1. Score curb / valley gutter at 15' O.C.
2. Provide 1/2" expansion joints at 90' O.C.
3. For transition of curb to curb opening inlet, see standard detail 9.50



TOWN of
WAKE FOREST

TOWN of WAKE FOREST, NC
Manual of Specifications, Standards and Design

**STD. CURB & GUTTER &
VALLEY GUTTER DETAIL**

Scale:
Not To Scale

Detail #:
9.02

Revision Date:
Feb., 2015

Sheet #:
1 of 1

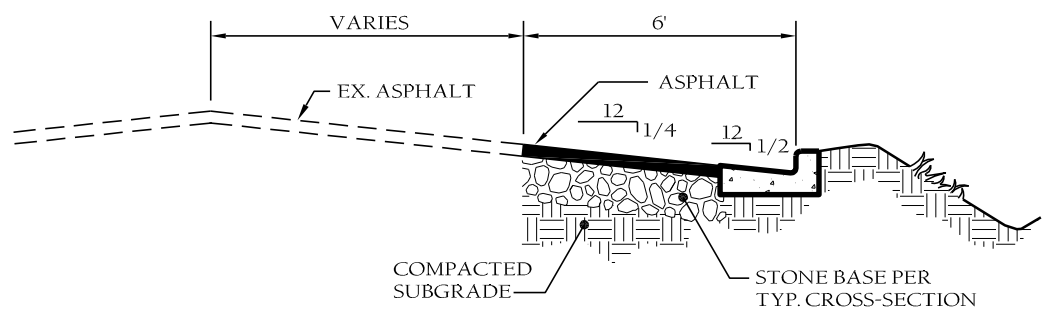

SECTION A-A
OFFSET CURB PAVEMENT WIDENING

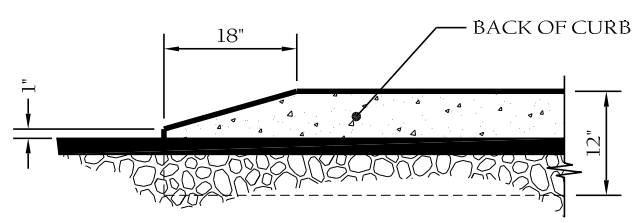
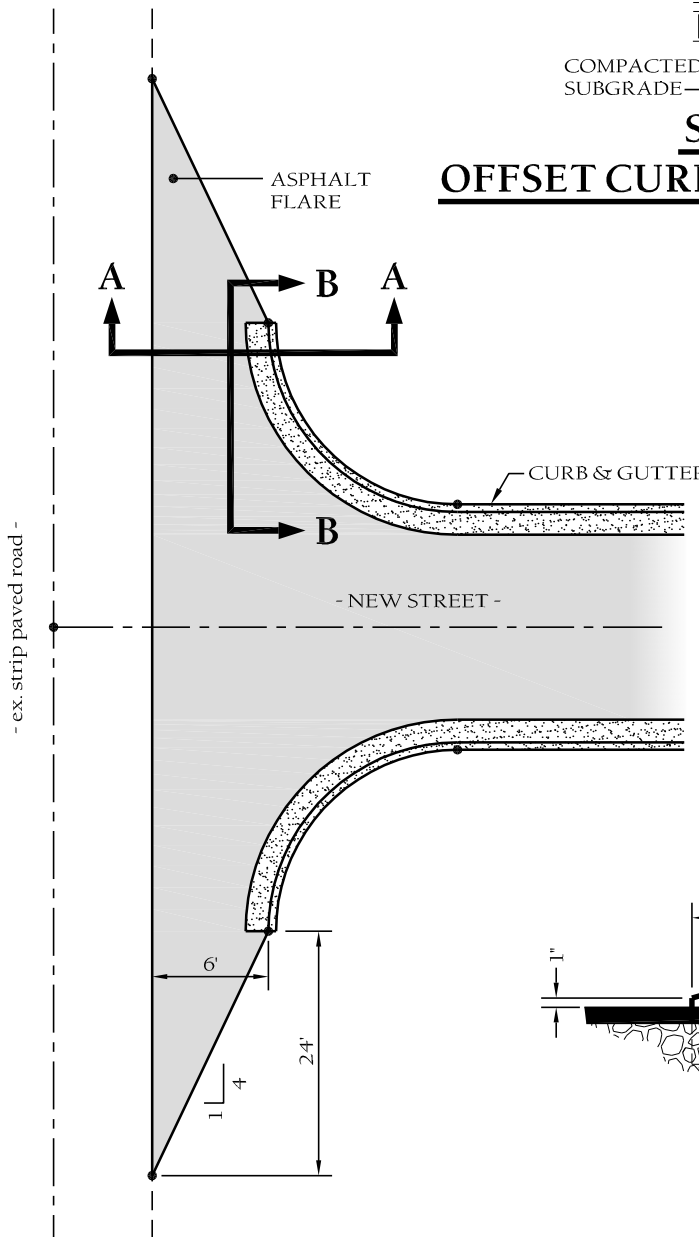

SECTION B-B
CURB END TAPER



TOWN of WAKE FOREST, NC
 Manual of Specifications, Standards and Design

TERMINAL END OF CURB
at SHOULDER SECTIONS

Scale: Not To Scale	Detail #: 9.03
Revision Date: Feb., 2015	Sheet #: 1 of 1

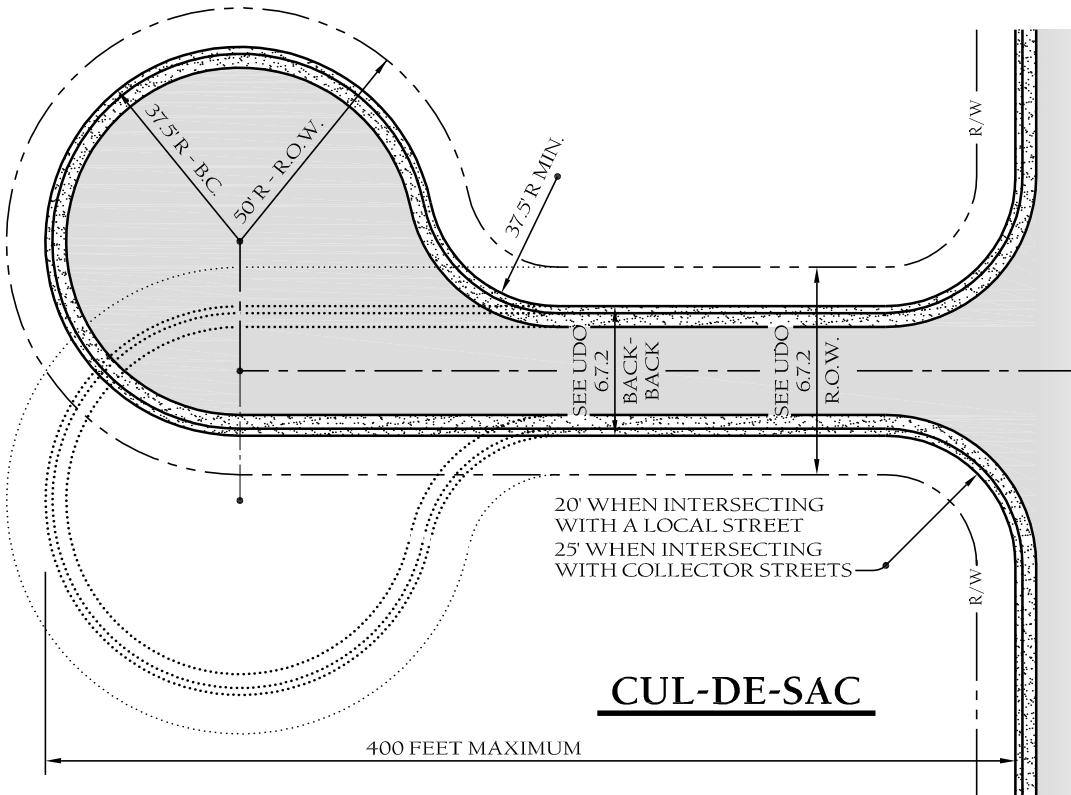
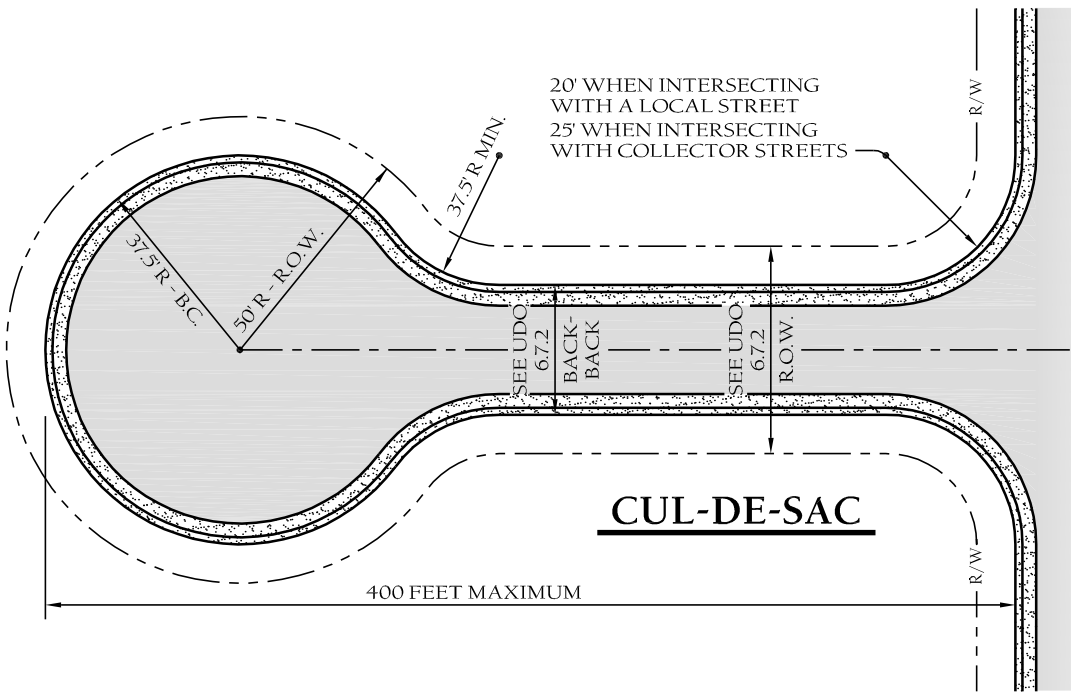

NOTES:

1. See UDO 6.7.2 for pavement and right-of-way dimensions.



TOWN of WAKE FOREST, NC
Manual of Specifications, Standards and Design

**CUL-DE-SAC
DIMENSIONS**

Scale:
Not To Scale

Detail #:
9.04

Revision Date:
Feb., 2015

Sheet #:
1 of 2

 ROW = RIGHT OF WAY

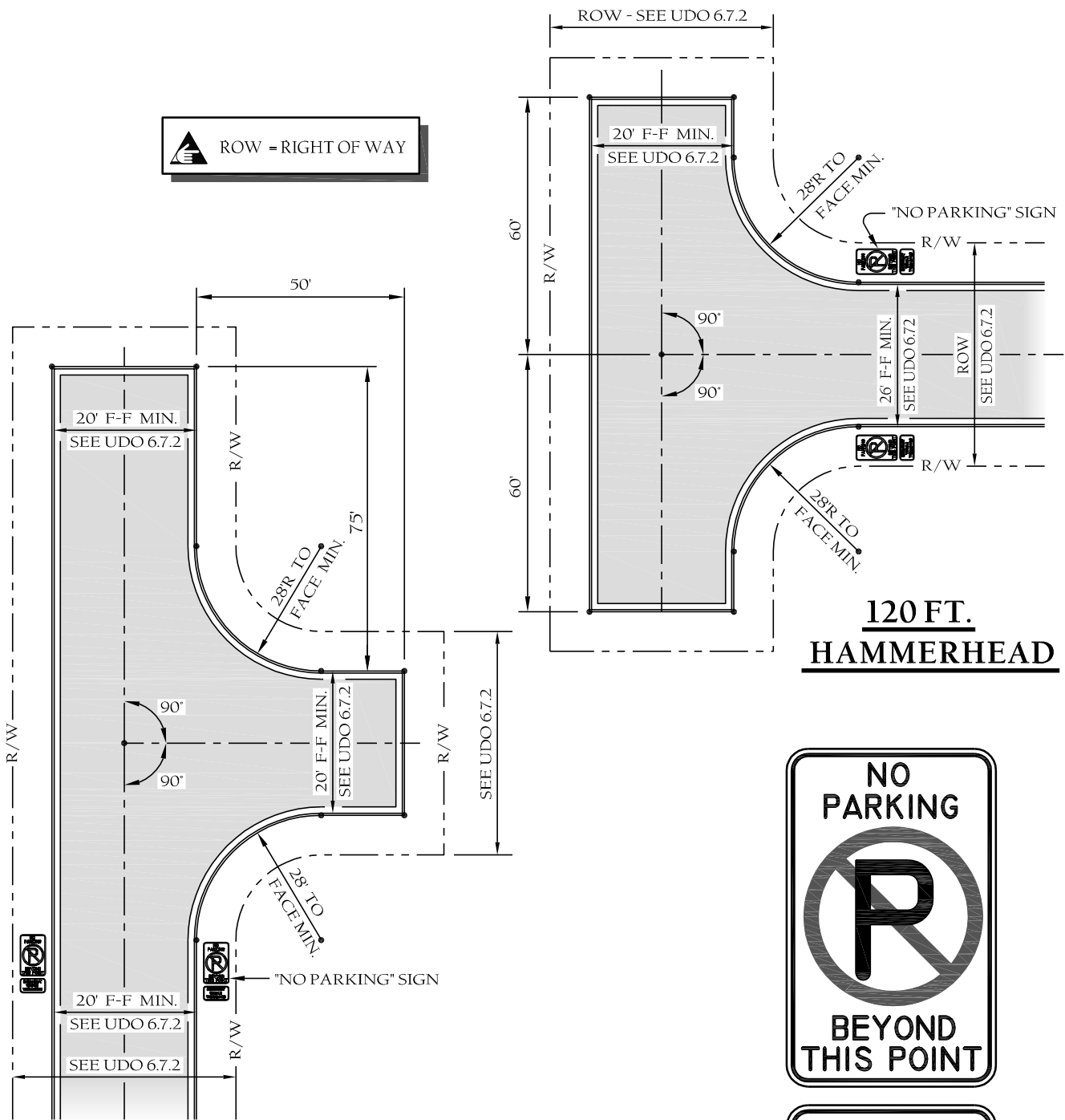

**120 FT.
HAMMERHEAD**

**ALTERNATE TO
120 FT. HAMMERHEAD**



**NO PARKING
SIGN**

NOTES:

1. See UDO 6.7.2 for pavement and right-of-way dimensions.
2. Ref: N.C. Fire Code Appendix B.



TOWN of WAKE FOREST, NC
Manual of Specifications, Standards and Design

**CUL-DE-SAC
DIMENSIONS**

Scale: Not To Scale	Detail #: 9.04
Revision Date: Feb., 2015	Sheet #: 2 of 2

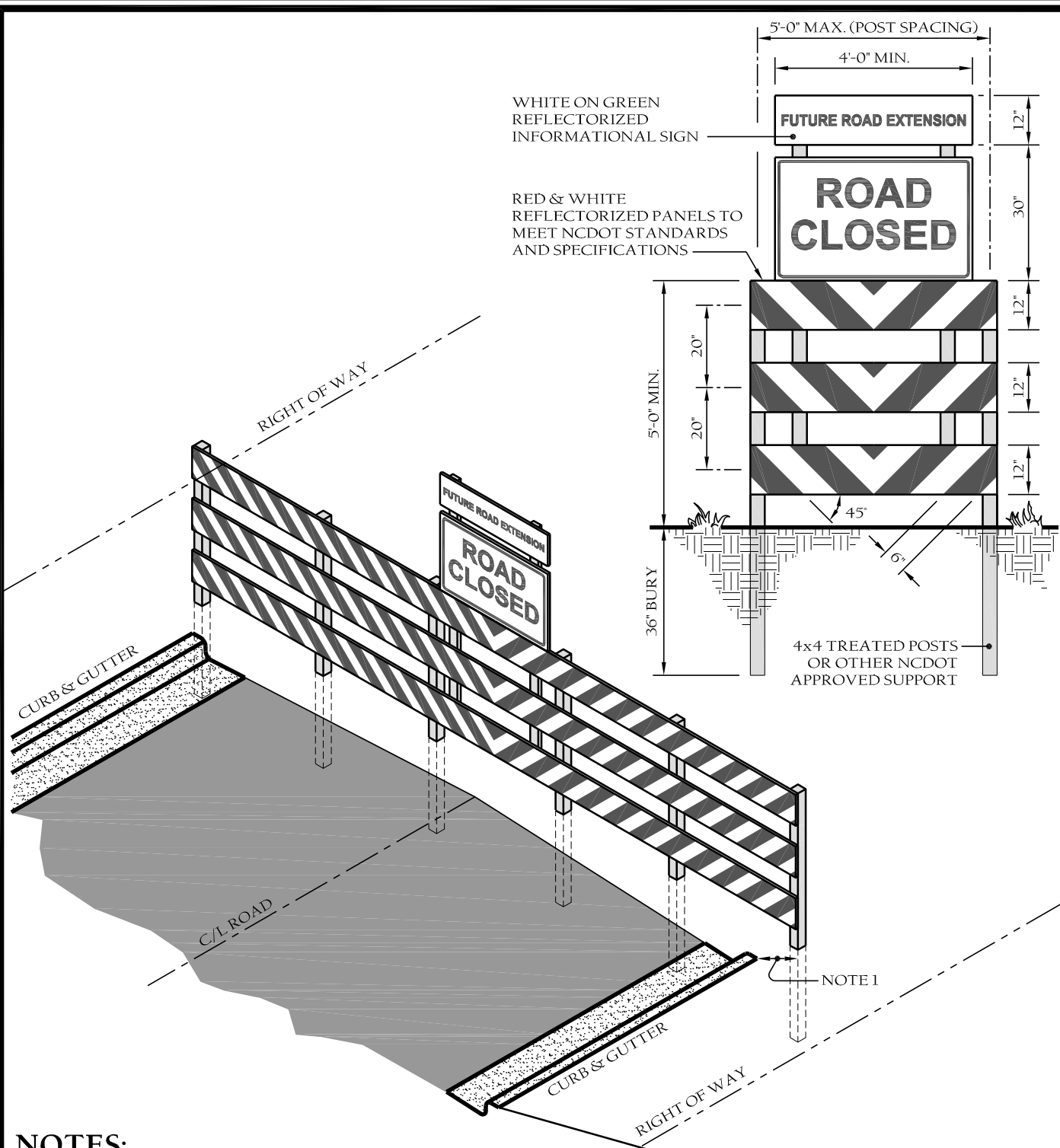

NOTES:

1. Barricade to be created across entire roadway including curb & gutter.
2. Advance warning sign W14-1 (DEAD END) shall be placed just after last intersection.
3. Markings for barricade rails shall be reflective and alternate red and white stripes.
4. "ROAD CLOSED" sign shall meet specifications of M.U.T.C.D. R11-2 and be required atop each barricade used.



TOWN of WAKE FOREST, NC
Manual of Specifications, Standards and Design

**DEAD END ROAD
BARRICADE**

Scale: Not To Scale	Detail #: 9.05
Revision Date: Feb., 2015	Sheet #: 1 of 1

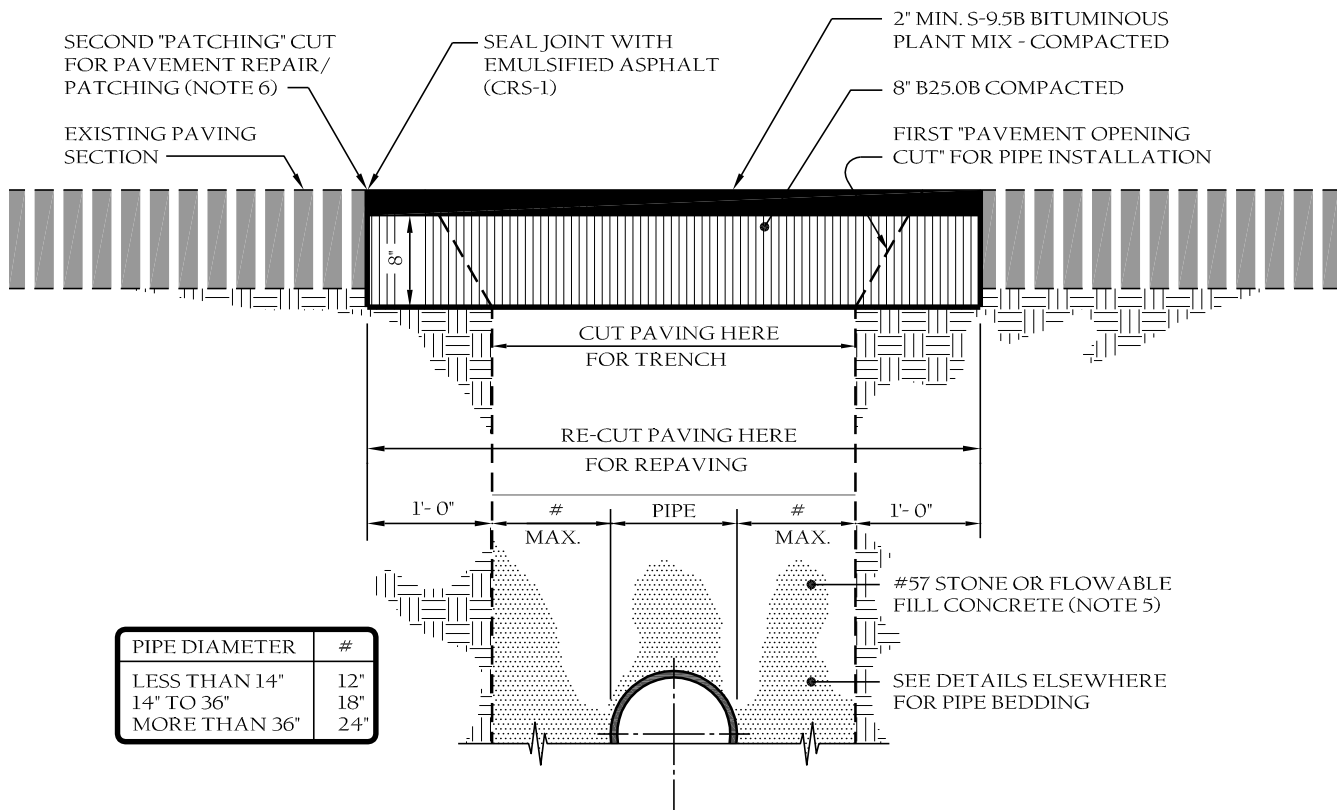

PIPE DIAMETER	#
LESS THAN 14"	12"
14" TO 36"	18"
MORE THAN 36"	24"

NOTES:

1. Pavement repairs shall have 8" compacted B25.0B and 2" topping of S9.5B mix. Compact to min. 92% Maximum Specific Gravity.
2. Trench is to be back filled in 6" lifts and compacted to 95% standard density as determined by AASHTO test method T-99 or ASTM D698 before pavement repairs are made. No excavated fill to be used for backfill. See detail 9.53.
3. Compaction test may be required at request of inspector.
4. All existing Town of Wake Forest paved streets and secondary roads which are open cut to install any utility, must be repaired according to this detail.
5. Fiber optic & gas: #57 stone or flowable fill concrete (minimum 30 psi) but min. 6" compacted class II or III (Definition in section 02210 - paragraph 2.1.1 of Specs) fill over top of fiber optic cable or gas pipe.
6. Existing pavement to be saw cut. Provide a smooth uniform pavement cut without jagged or irregular edge.
7. If paving is not done immediately, fill final 10" with ABC until ready to pave patch.



TOWN of WAKE FOREST, NC
Manual of Specifications, Standards and Design

**FULL DEPTH ASPHALT REPAIR
DETAIL FOR UTILITY CUTS**

Scale:
Not To Scale

Detail #:
9.06

Revision Date:
Feb., 2015

Sheet #:
1 of 1

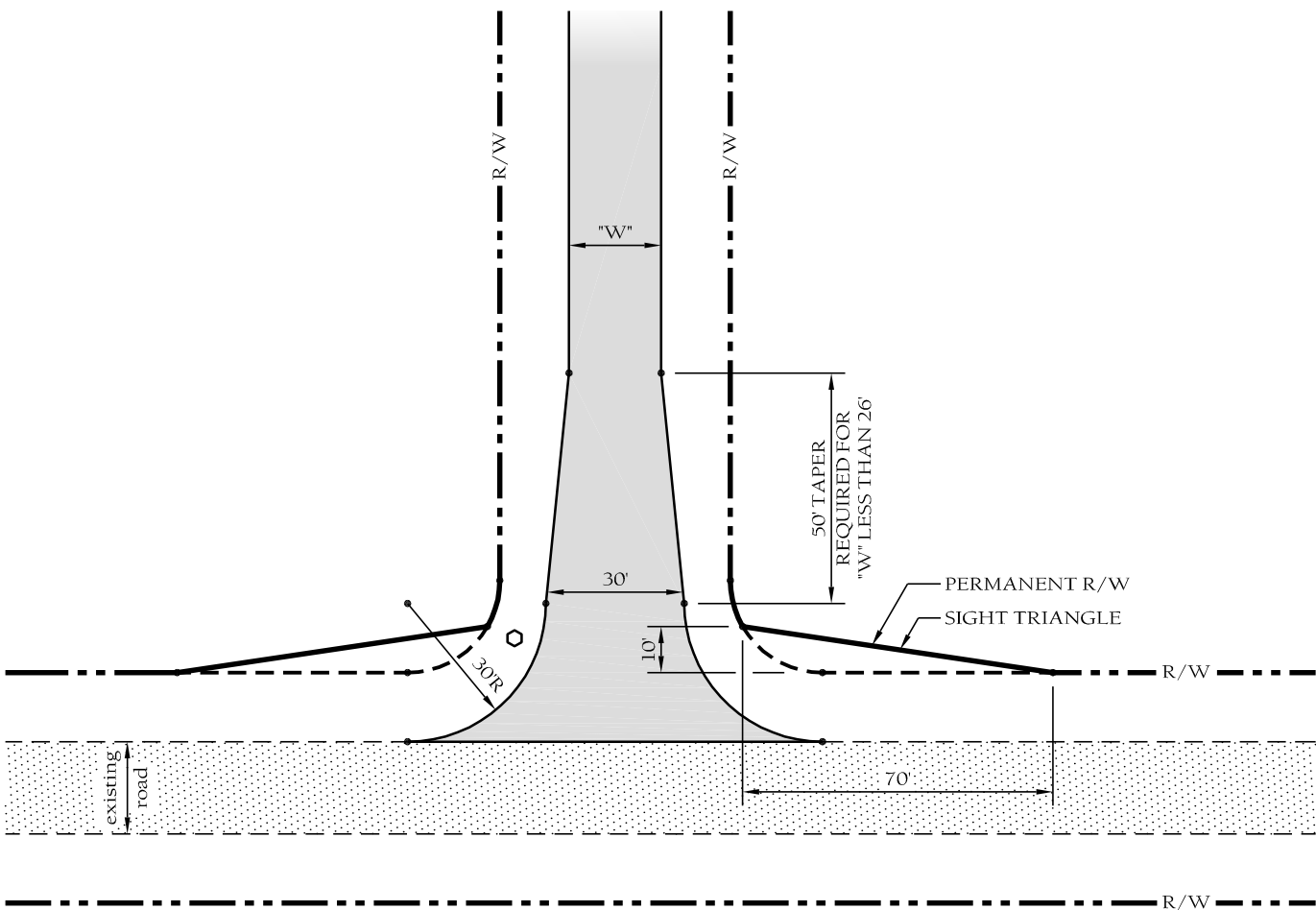

TOWN of WAKE FOREST, NC
Manual of Specifications, Standards and Design

**TIE-IN OF STREETS at DOT
SHOULDER ROADS - STREETS**

Scale: Not To Scale	Detail #: 9.07
Revision Date: Feb., 2015	Sheet #: 1 of 1

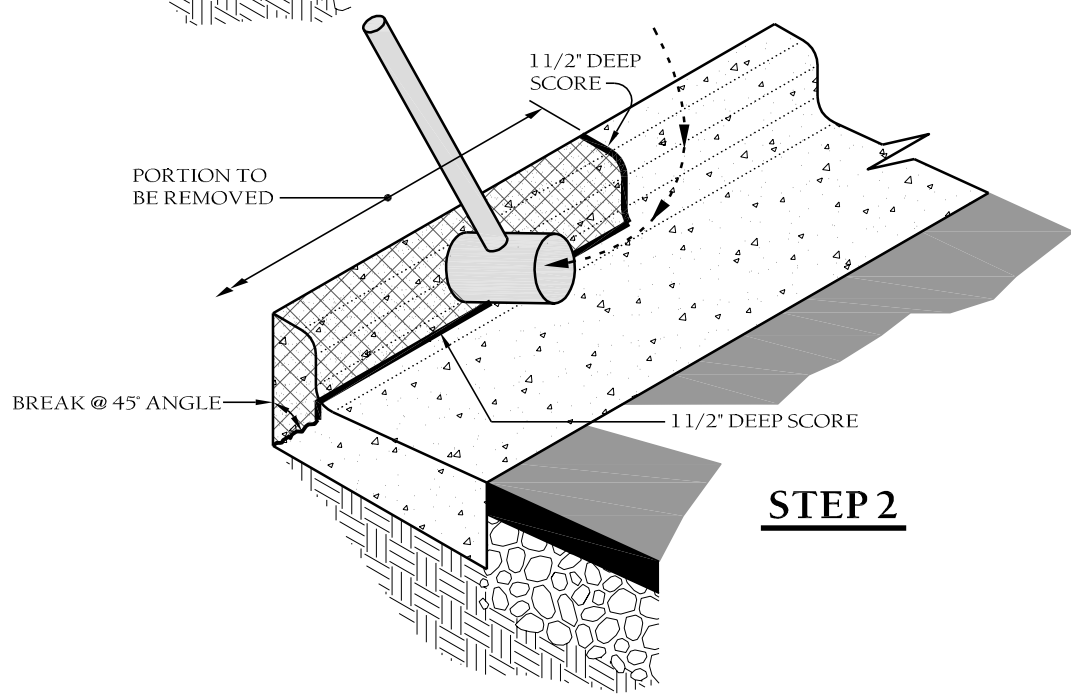
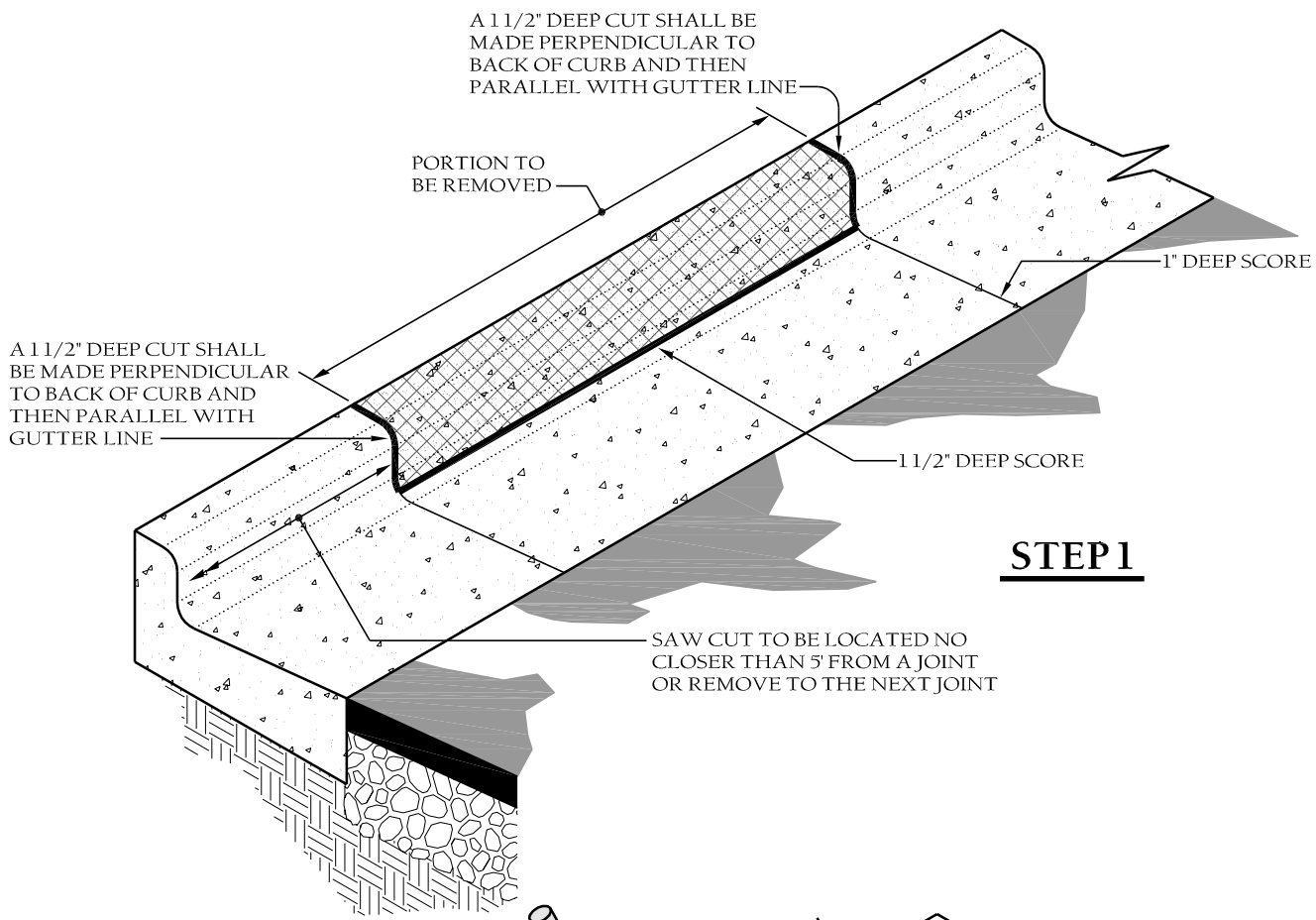

TOWN of WAKE FOREST, NC
Manual of Specifications, Standards and Design

**STREET CURB CUT FOR
DRIVEWAYS ON C&G STREETS**

Scale: Not To Scale	Detail #: 9.08
Revision Date: Feb., 2015	Sheet #: 1 of 3

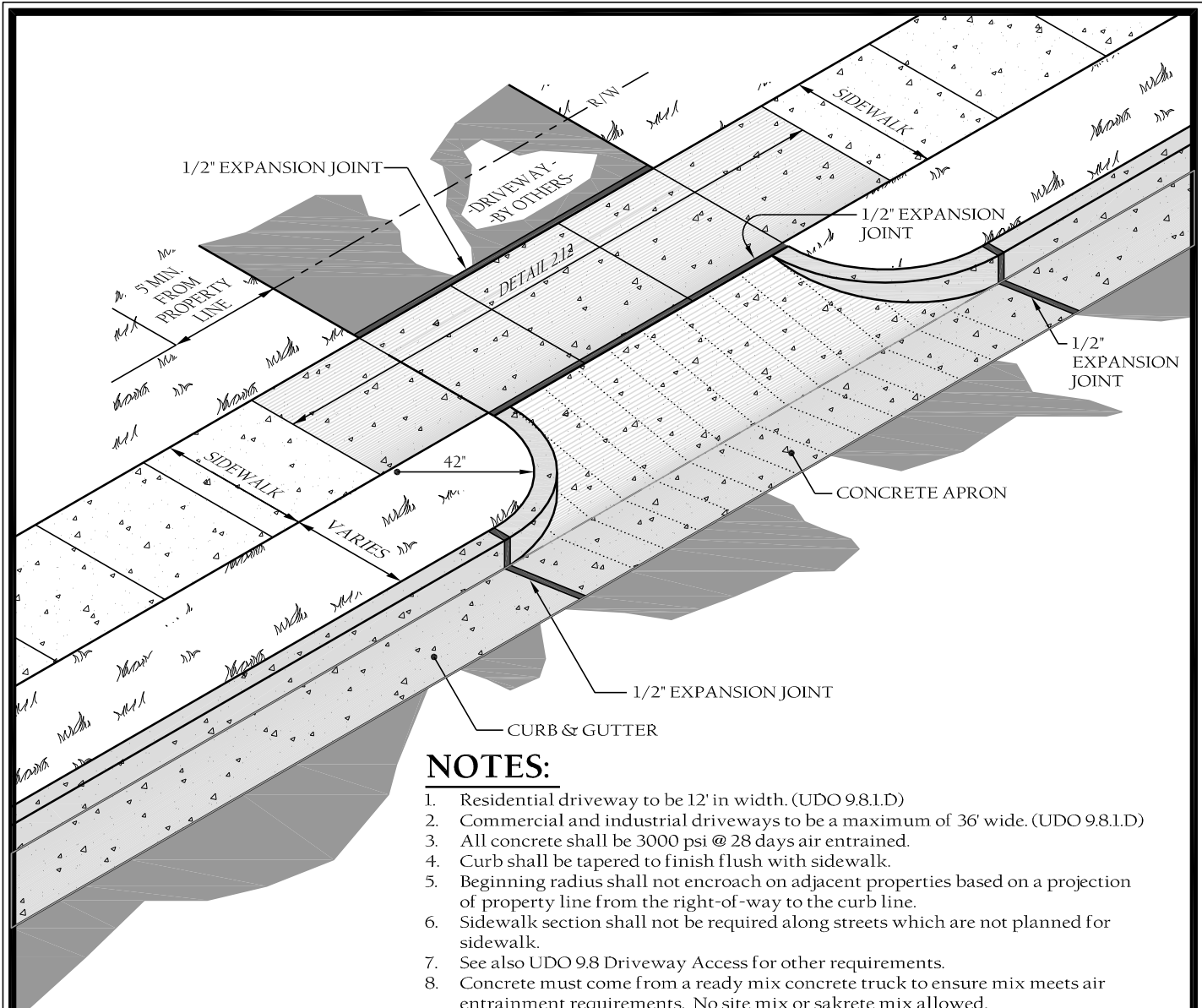

NOTES:

1. Residential driveway to be 12' in width. (UDO 9.8.1.D)
2. Commercial and industrial driveways to be a maximum of 36' wide. (UDO 9.8.1.D)
3. All concrete shall be 3000 psi @ 28 days air entrained.
4. Curb shall be tapered to finish flush with sidewalk.
5. Beginning radius shall not encroach on adjacent properties based on a projection of property line from the right-of-way to the curb line.
6. Sidewalk section shall not be required along streets which are not planned for sidewalk.
7. See also UDO 9.8 Driveway Access for other requirements.
8. Concrete must come from a ready mix concrete truck to ensure mix meets air entrainment requirements. No site mix or sakrete mix allowed.

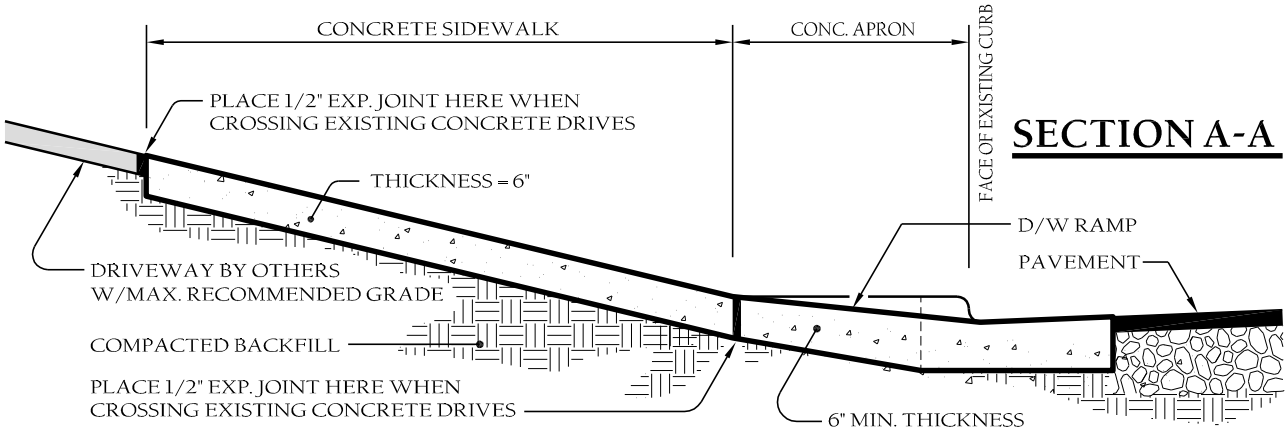

TOWN of WAKE FOREST, NC
 Manual of Specifications, Standards and Design

**STREET CURB CUT FOR
 DRIVEWAYS ON C&G STREETS**

Scale: Not To Scale	Detail #: 9.08
Revision Date: Feb., 2015	Sheet #: 2 of 3

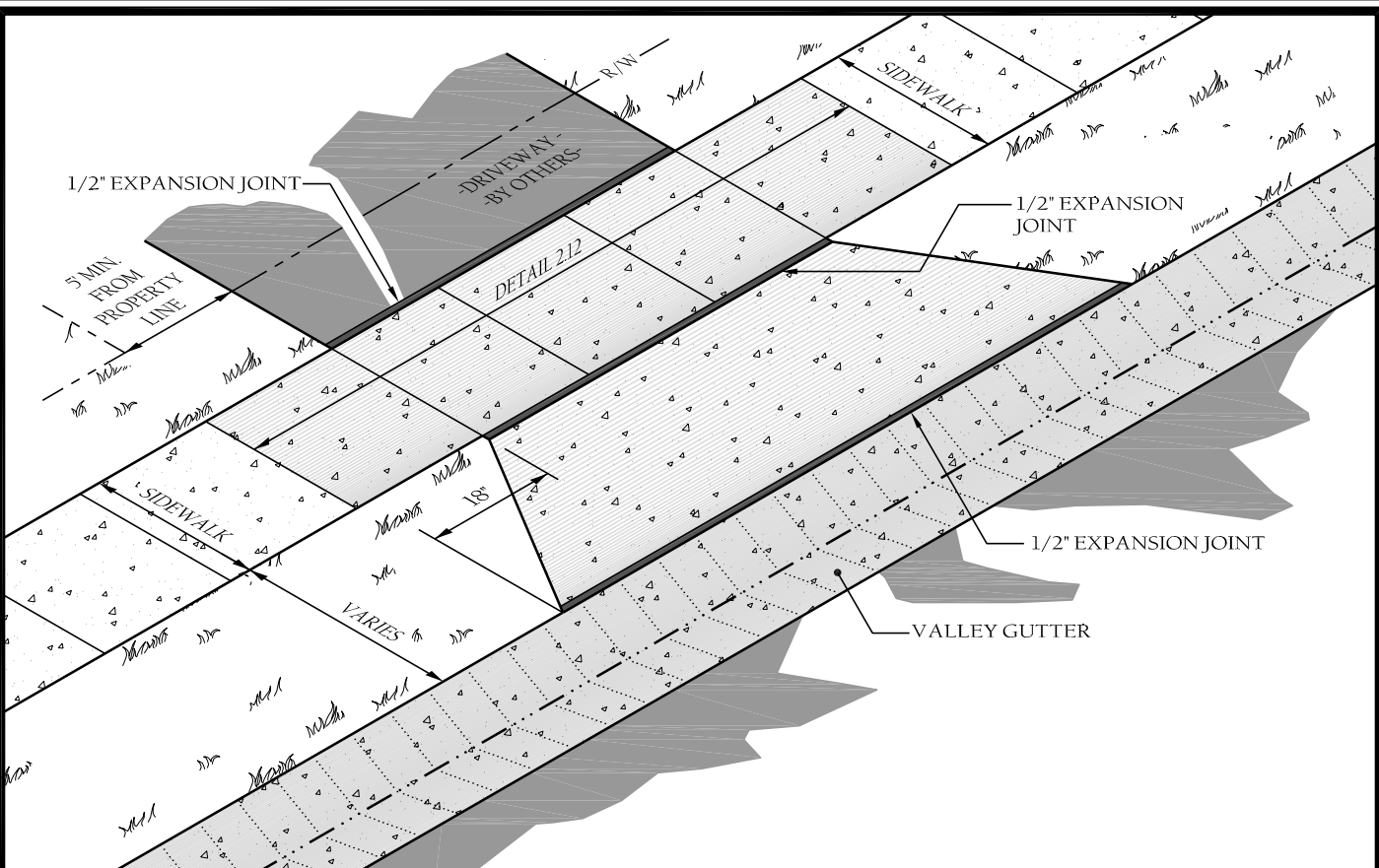

NOTES:

1. Residential driveway to be 12' in width. (UDO 9.8.1.D)
2. Commercial and industrial driveways to be a maximum of 36' wide. (UDO 9.8.1.D)
3. All concrete shall be 3000 psi @ 28 days air entrained.
4. Curb shall be tapered to finish flush with sidewalk.
5. Beginning radius shall not encroach on adjacent properties based on a projection of property line from the right-of-way to the curb line.
6. Sidewalk section shall not be required along streets which are not planned for sidewalk.
7. See also UDO 9.8 Driveway Access for other requirements.
8. Concrete must come from a ready mix concrete truck to ensure mix meets air entrainment requirements. No site mix or sakrete mix allowed.

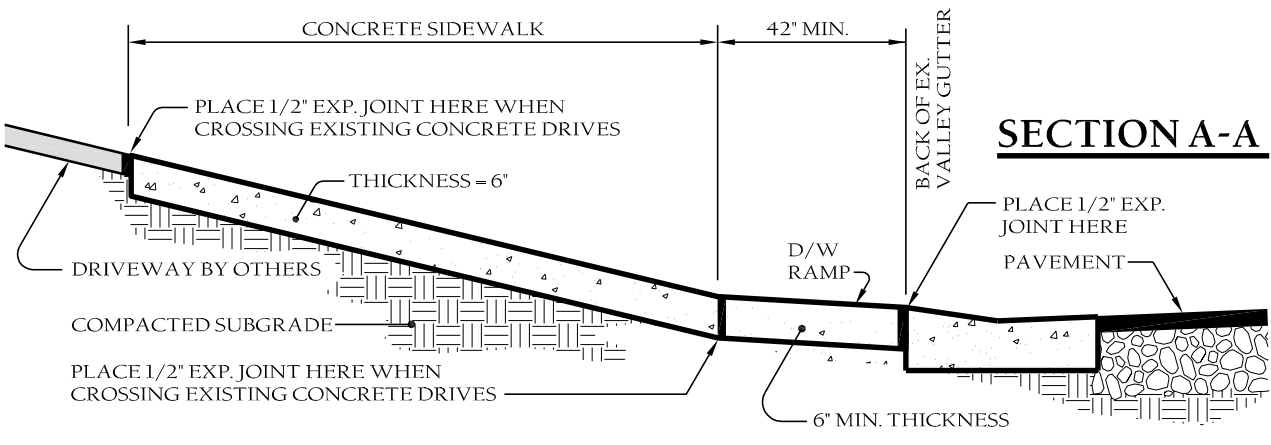

TOWN of WAKE FOREST, NC
Manual of Specifications, Standards and Design

FLARED DRIVEWAY ENTRANCE TO VALLEY GUTTER

Scale: Not To Scale	Detail #: 9.08
Revision Date: Feb., 2015	Sheet #: 3 of 3

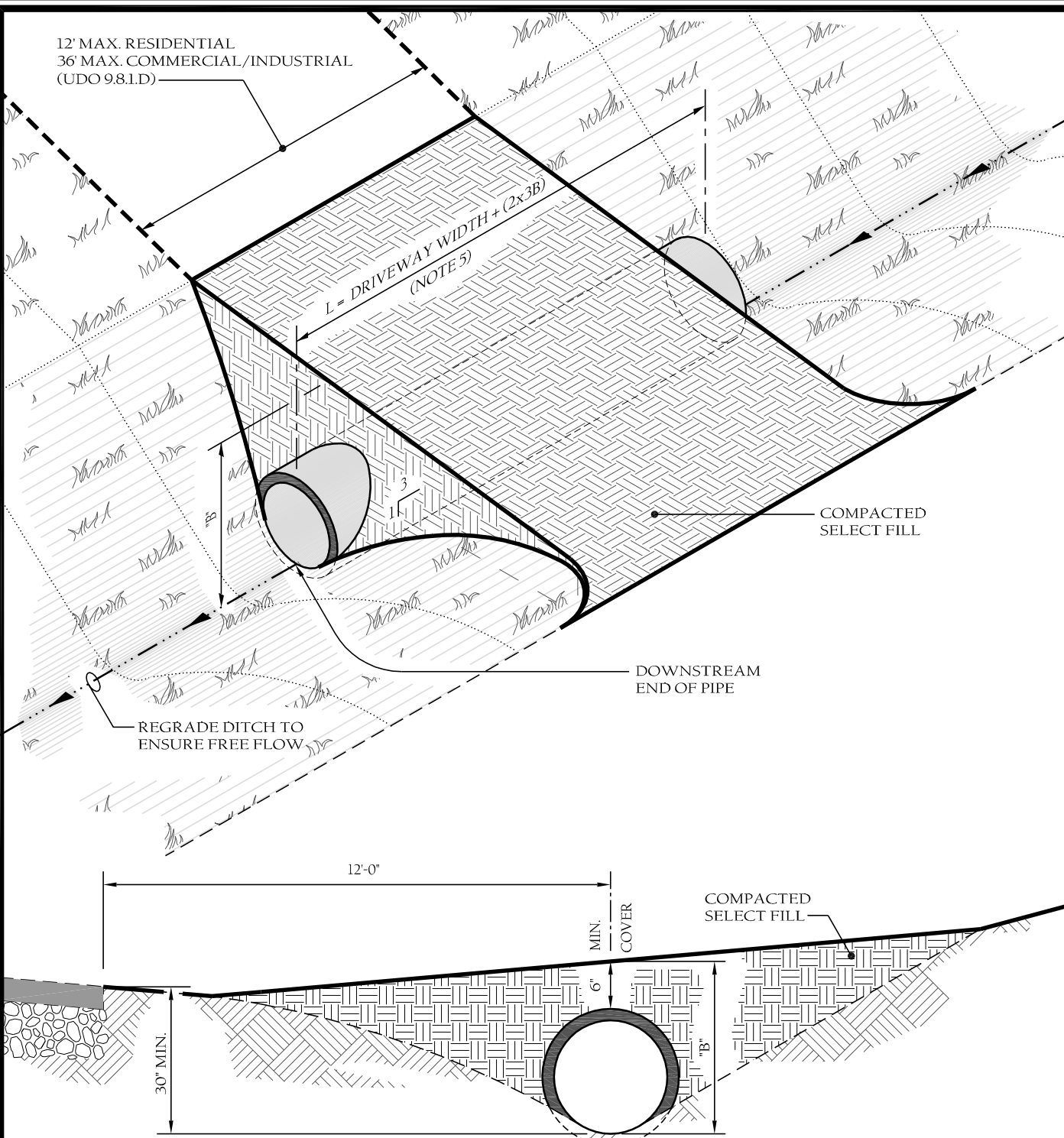

NOTES:

1. D/w pipe 18" and above to have flared end sections.
2. Minimum diameter pipe to be 15" class III "C" wall.
3. D/W pipe to be staked by N.C. licensed surveyor.
4. Driveway pipe shall be concrete pipe only.
5. "L" to be rounded up to next 4' increment.
6. Decorative headwalls may be allowed at discretion of Town's Engineer. An encroachment agreement will be required.



TOWN of WAKE FOREST, NC
Manual of Specifications, Standards and Design

INSTALLATION OF D/W PIPE IN STREET SECTION

Scale: Not To Scale	Detail #: 9.09
Revision Date: Feb., 2015	Sheet #: 1 of 1

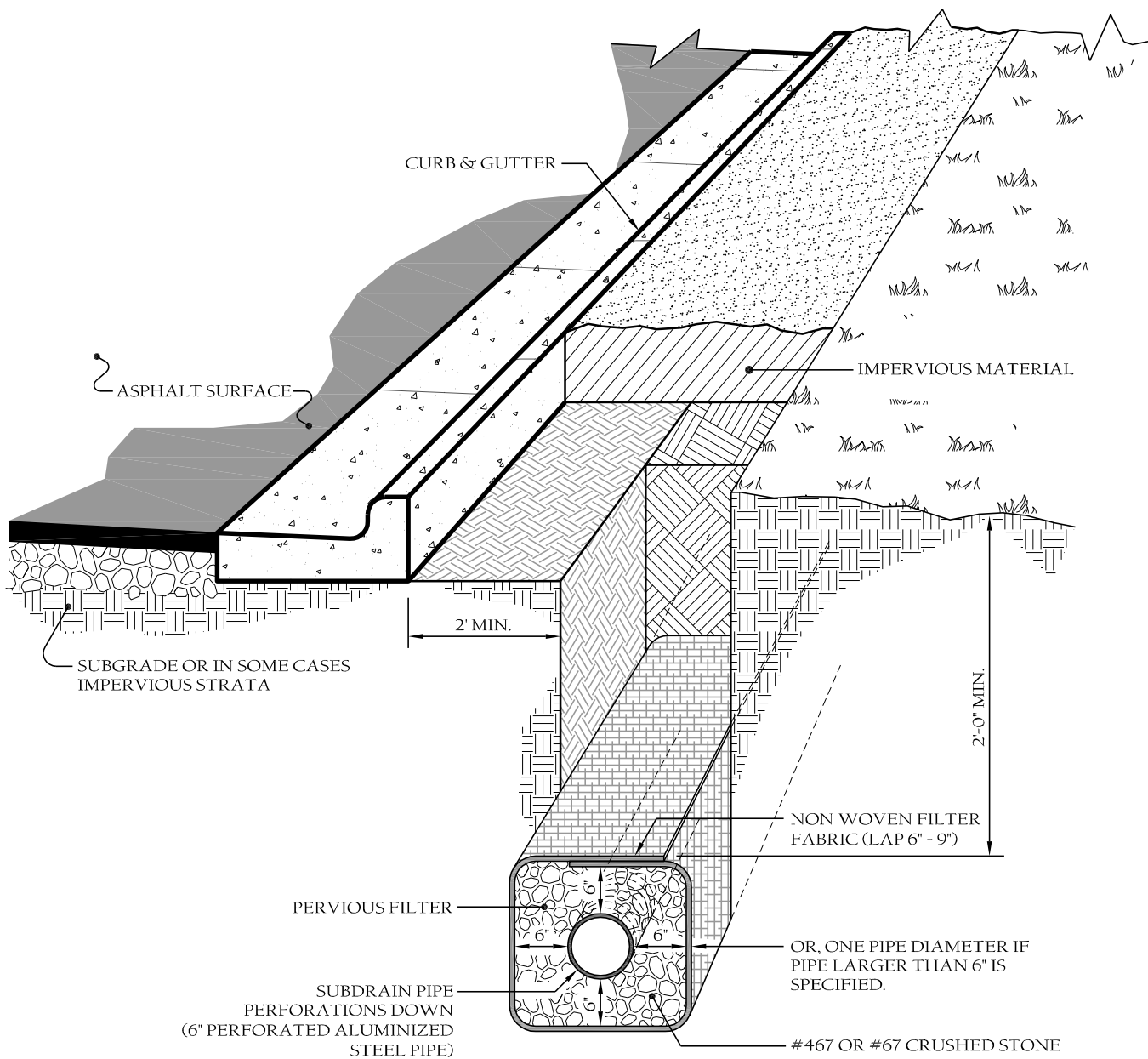

NOTES:

- Subdrains shall tie or empty into catch basin only. No ties or connections will be allowed on a pipe culvert of any kind.



TOWN of WAKE FOREST, NC
Manual of Specifications, Standards and Design

**STANDARD SUBDRAIN
BEHIND CURB & GUTTER**

Scale:
Not To Scale

Detail #:
9.10

Revision Date:
Feb., 2015

Sheet #:
1 of 1

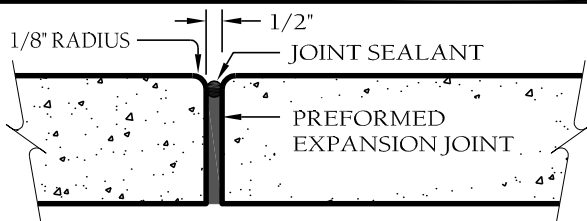

TYPICAL EXPANSION JOINT DETAIL

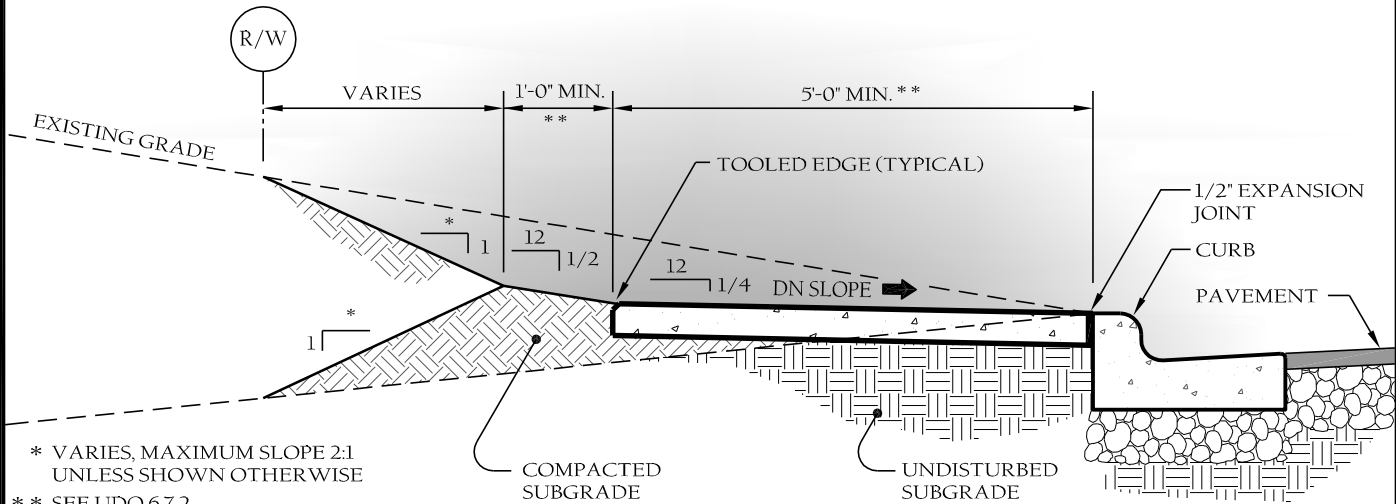

SIDEWALK WITHOUT UTILITY STRIP

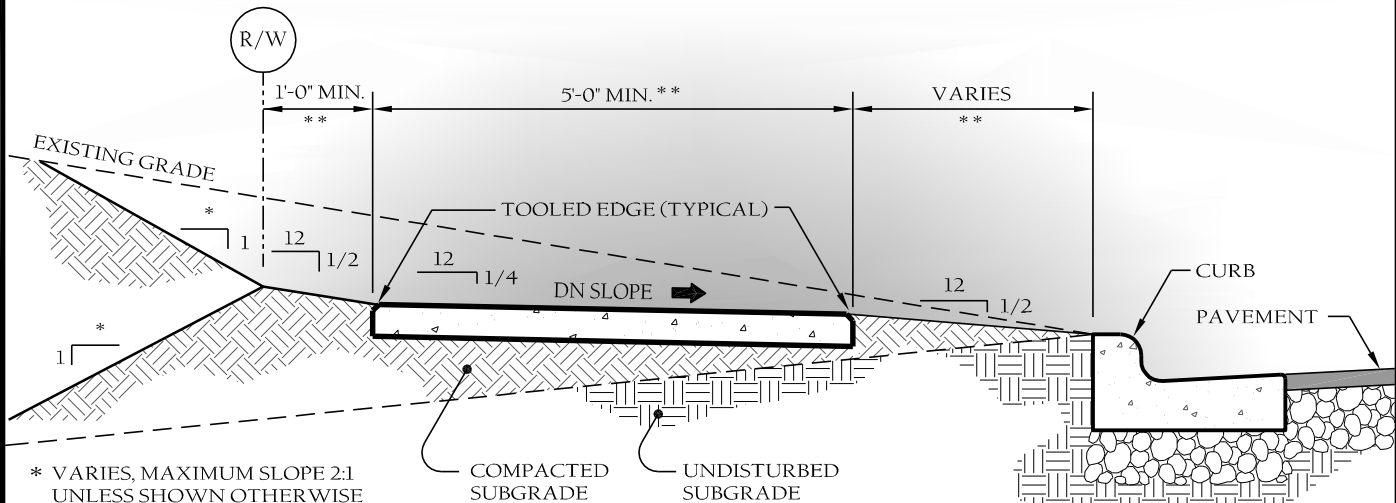

SIDEWALK WITH UTILITY STRIP

NOTES:

1. Provide 3/4" deep tooled score at 5'-0" O.C.
2. Expansion joints to be placed 30'-0" O.C. longitudinally, adjacent to curbs, and when butting existing structures, concrete, or buildings.
3. Concrete to be 3,000 P.S.I. at 28 days, air-entrained.
4. Subgrade should not contain organic matter or plastic clays. When found, refer to specs or contact engineer for directions.
5. Areas of fill are to be compacted to 95% standard proctor using NCDOT Class III borrow or better. Remove topsoil before placing borrow.
8. Concrete must come from a ready mix concrete truck to ensure mix meets air entrainment requirements. No site mix or sakrete mix allowed.
9. See Specification 02400, paragraph 2.1.3 & 2.1.4 for expansion joint & joint sealer specs.



TOWN of WAKE FOREST, NC
Manual of Specifications, Standards and Design

TYP SIDEWALK in
CUT or FILL SECTIONS

Scale:
Not To Scale

Detail #:
9.11

Revision Date:
Feb., 2015

Sheet #:
1 of 1

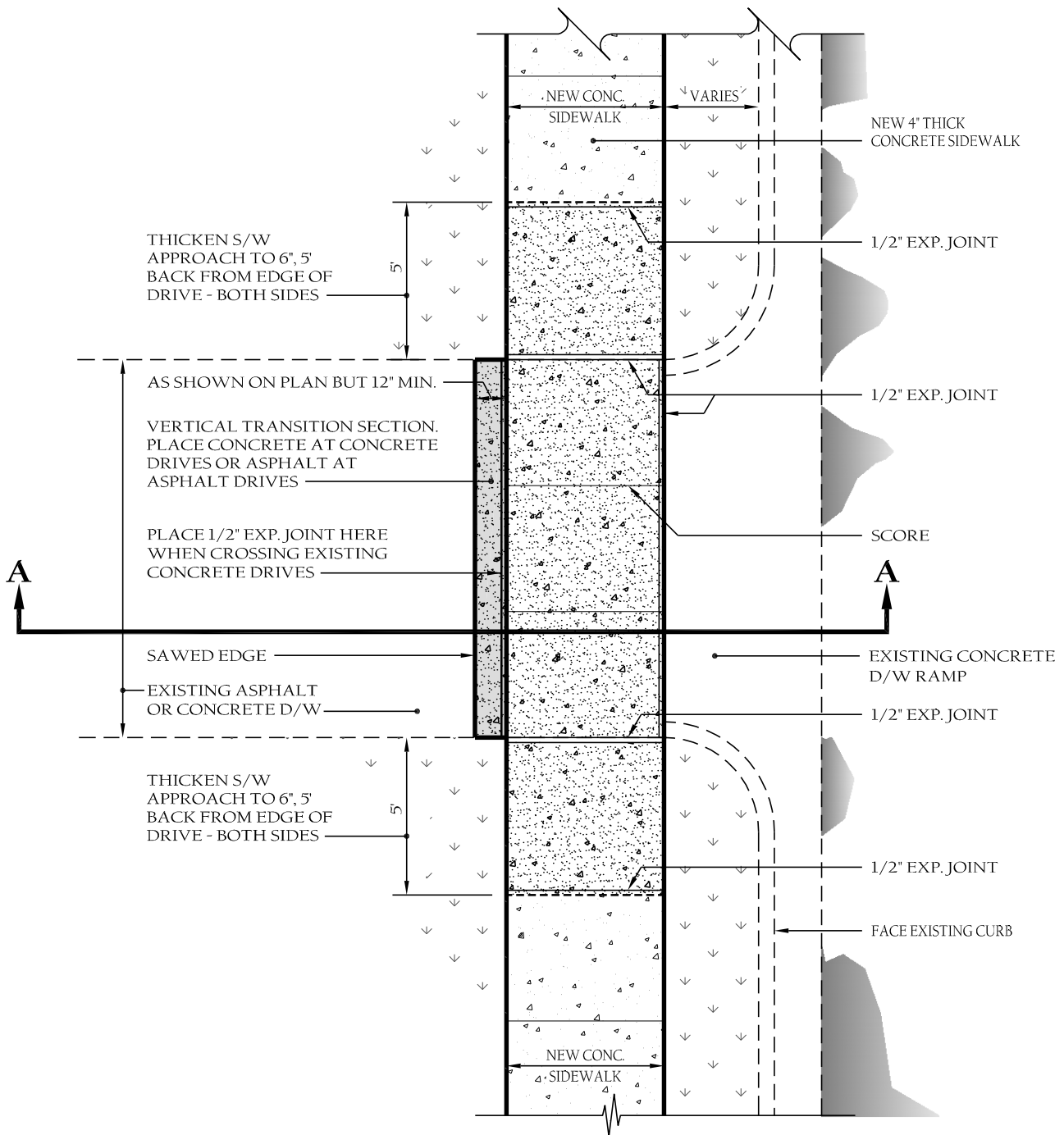

NOTES:

- Concrete must come from a ready mix concrete truck to ensure mix meets air entrainment requirements. No site mix or sakrete mix allowed.



TOWN of WAKE FOREST, NC
Manual of Specifications, Standards and Design

SIDEWALK DETAIL X-ING EX. DRIVEWAYS

Scale:
Not To Scale

Detail #:
9.12

Revision Date:
Feb., 2015

Sheet #:
1 of 2

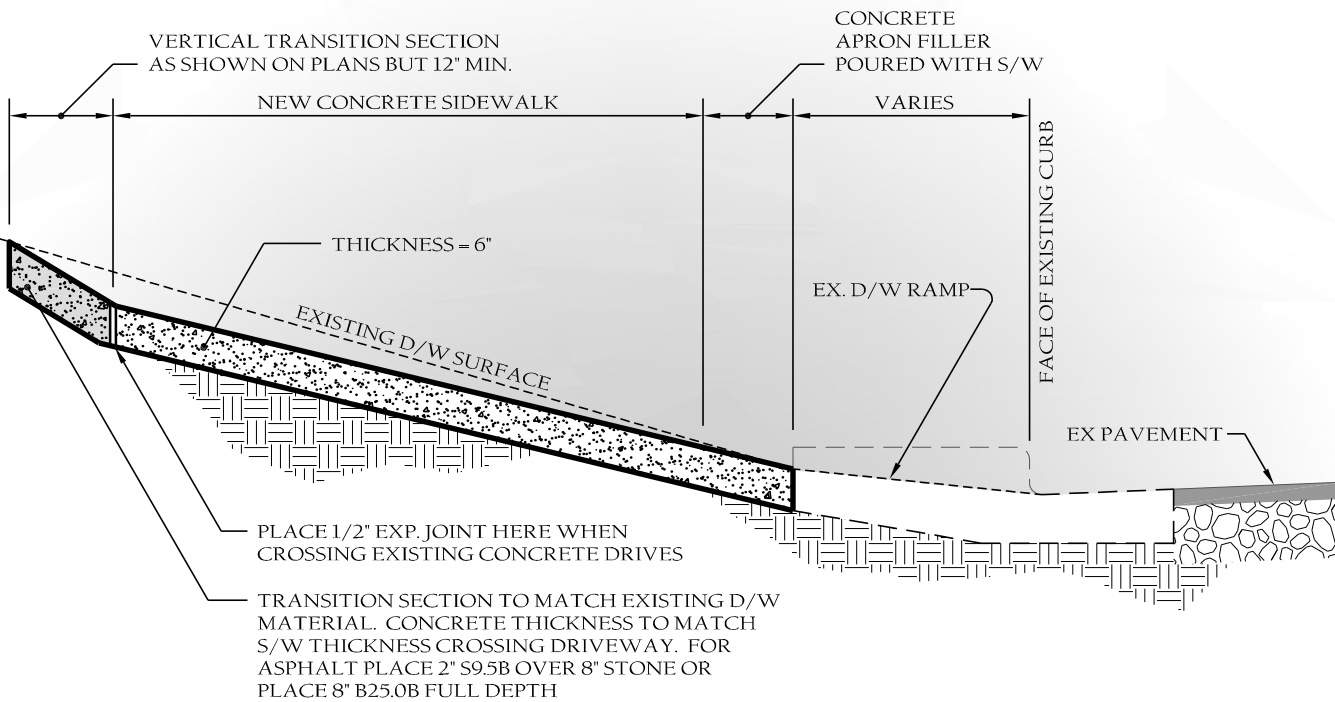

SECTION A-A



TOWN of WAKE FOREST, NC
 Manual of Specifications, Standards and Design

**SIDEWALK DETAIL X-ING
 EX. DRIVEWAYS**

Scale:
 Not To Scale

Detail #:
9.12

Revision Date:
 Feb., 2015

Sheet #:
 2 of 2

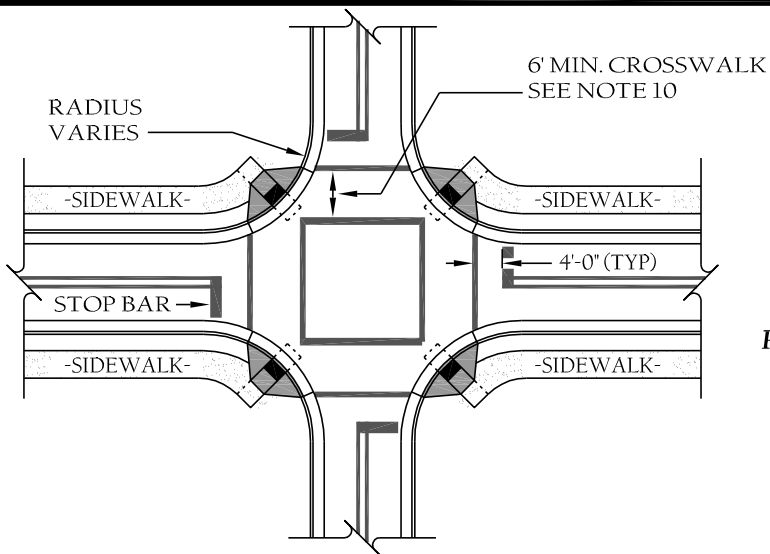

FOR CROSSING INTERSECTIONS
 DETAIL SHOWING TYPICAL LOCATION OF SINGLE CURB RAMPS, PEDESTRIAN CROSSWALKS AND STOP LINES FOR TEE INTERSECTIONS

FOR CROSSING INTERSECTIONS
 DETAIL SHOWING TYPICAL LOCATION OF DUAL CURB RAMPS, PEDESTRIAN CROSSWALKS AND STOP LINES FOR TEE INTERSECTIONS

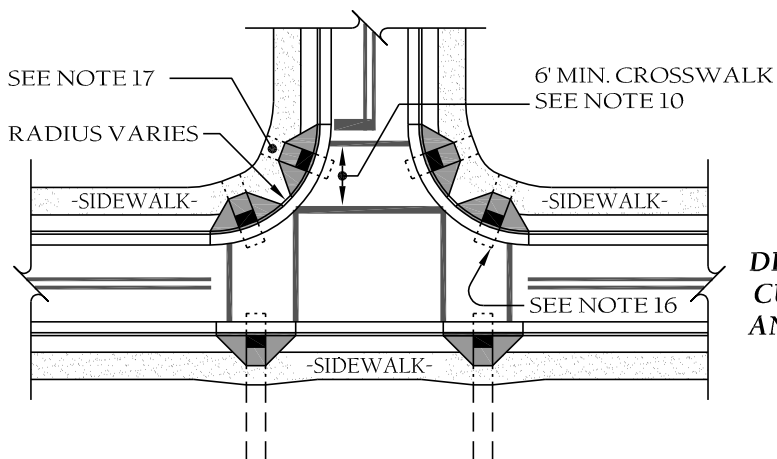
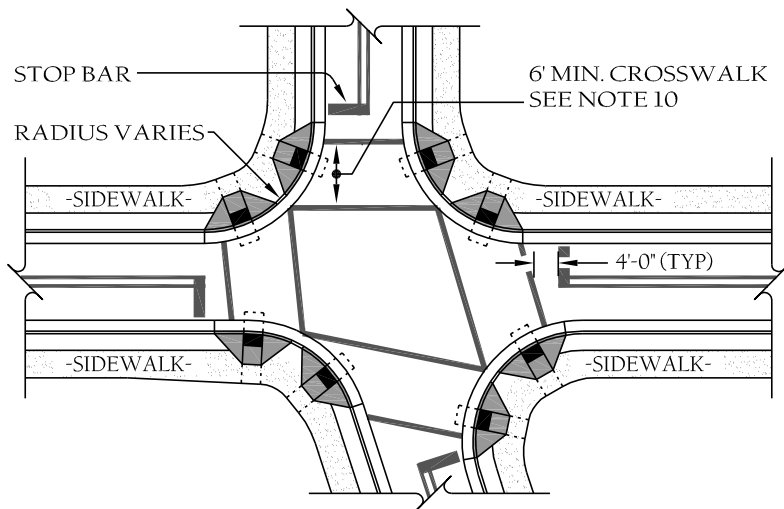

FOR TEE INTERSECTIONS
 DETAIL SHOWING TYPICAL LOCATION OF CURB RAMPS, PEDESTRIAN CROSSWALKS AND STOP LINES FOR TEE INTERSECTIONS

	PROPOSED CURB RAMP
	PROPOSED OR FUTURE SIDEWALK



TOWN of WAKE FOREST, NC
 Manual of Specifications, Standards and Design

**STANDARD CURB RAMP
 PLACEMENT DETAIL**

Scale:
 Not To Scale

Detail #:
9.13

Revision Date:
 Feb., 2015

Sheet #:
 1 of 15

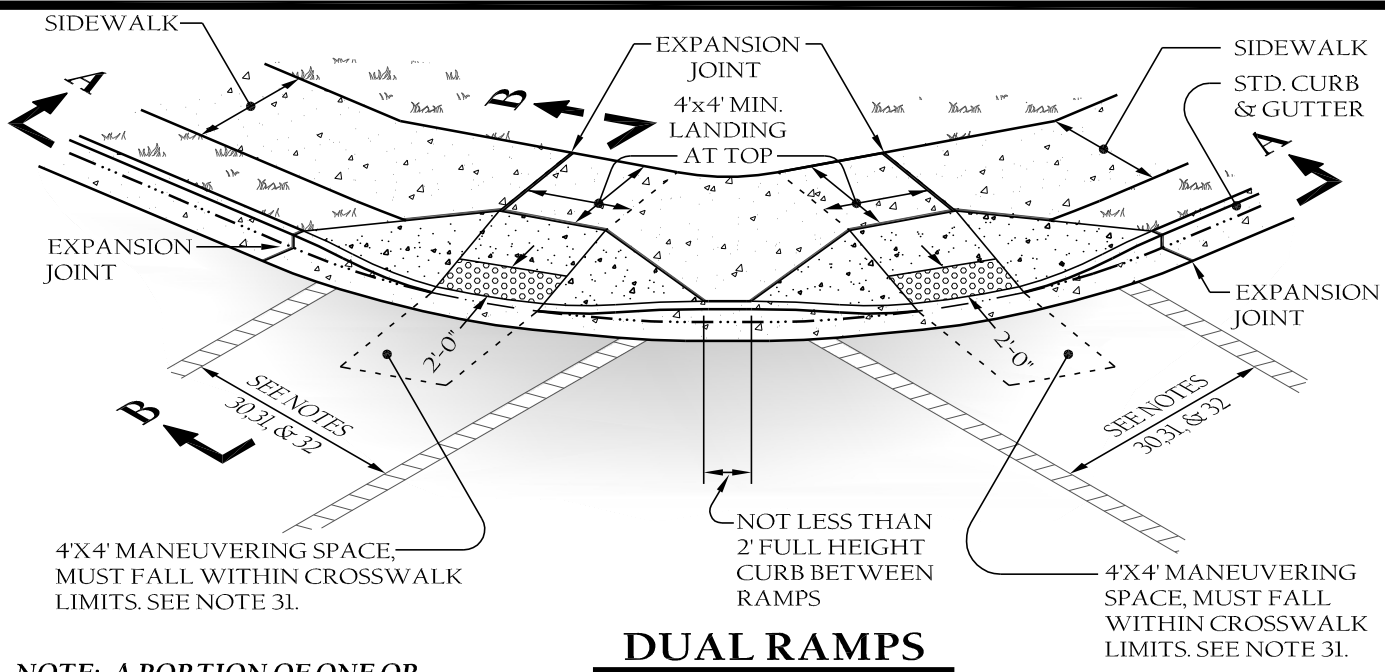

DUAL RAMPS
ANY RADII

NOTE: A PORTION OF ONE OR BOTH RAMPS MAY EXTEND OUTSIDE THE RETURNS

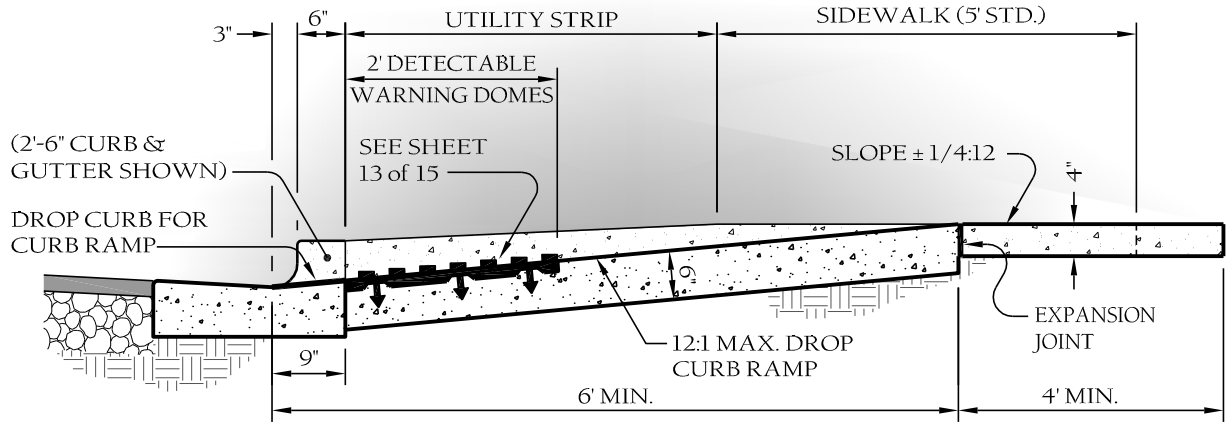
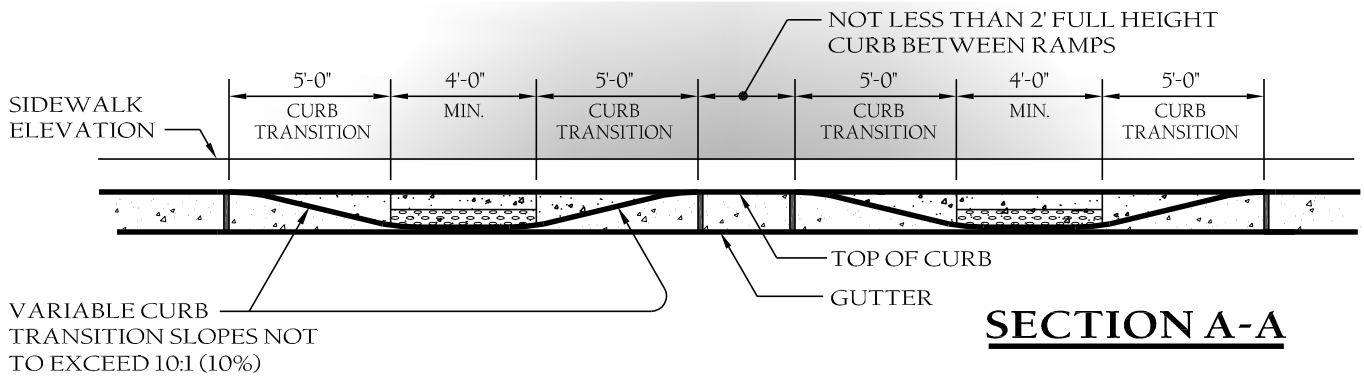

TOWN of WAKE FOREST, NC
Manual of Specifications, Standards and Design

STANDARD CURB RAMP
DETAILS

Scale: Not To Scale	Detail #: 9.13
Revision Date: Feb., 2015	Sheet #: 2 of 15

ISOMETRIC VIEW

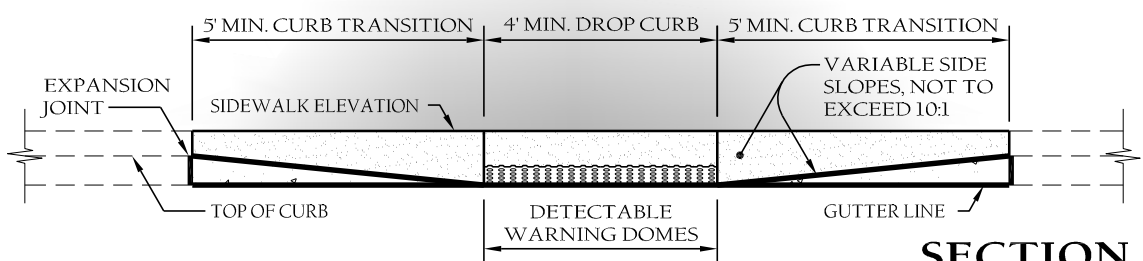
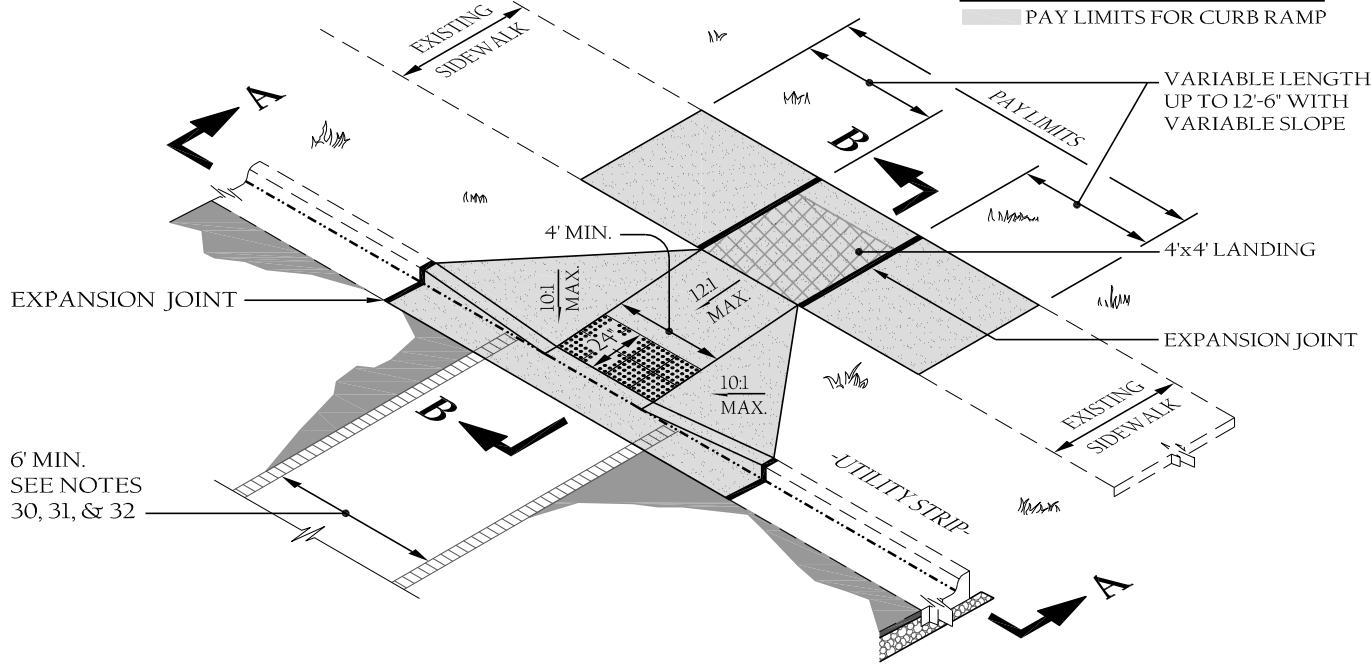

SECTION A-A

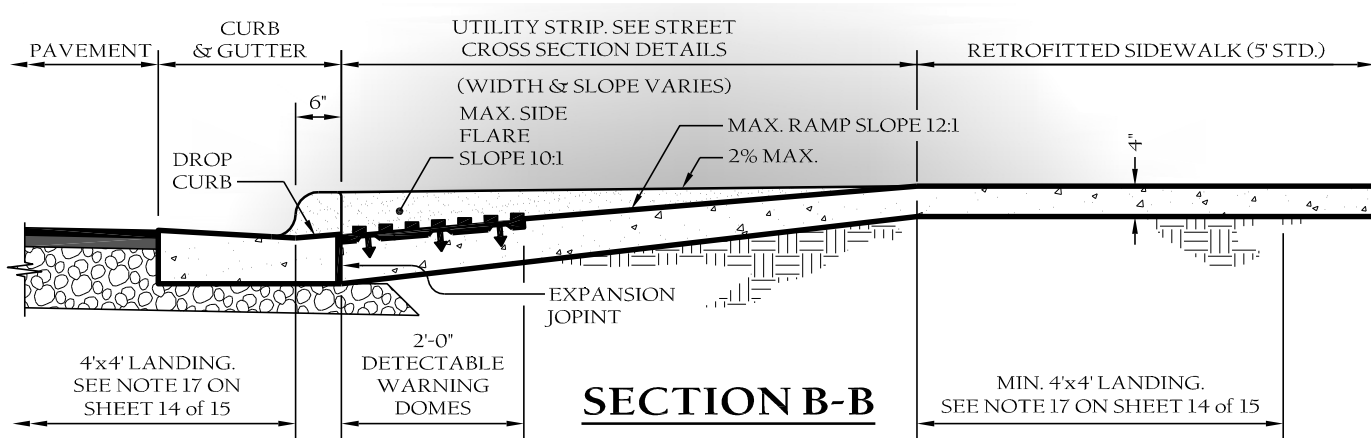

SECTION B-B

NOTES:

1. Detectable warning domes will cover 2'-0" length and full width of the ramp floor as shown on sheet 13 of 15.



TOWN of WAKE FOREST, NC
Manual of Specifications, Standards and Design

SINGLE CURB RAMP WITH EXISTING CURB & GUTTER

Scale: Not To Scale	Detail #: 9.13
Revision Date: Feb., 2015	Sheet #: 3 of 15

ISOMETRIC VIEW

PAY LIMITS FOR CURB RAMP

"W" PROPOSED OR FUTURE
SIDEWALK (5' STD.)

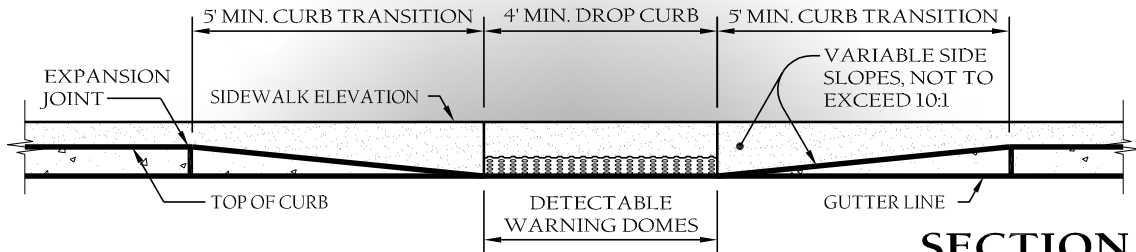
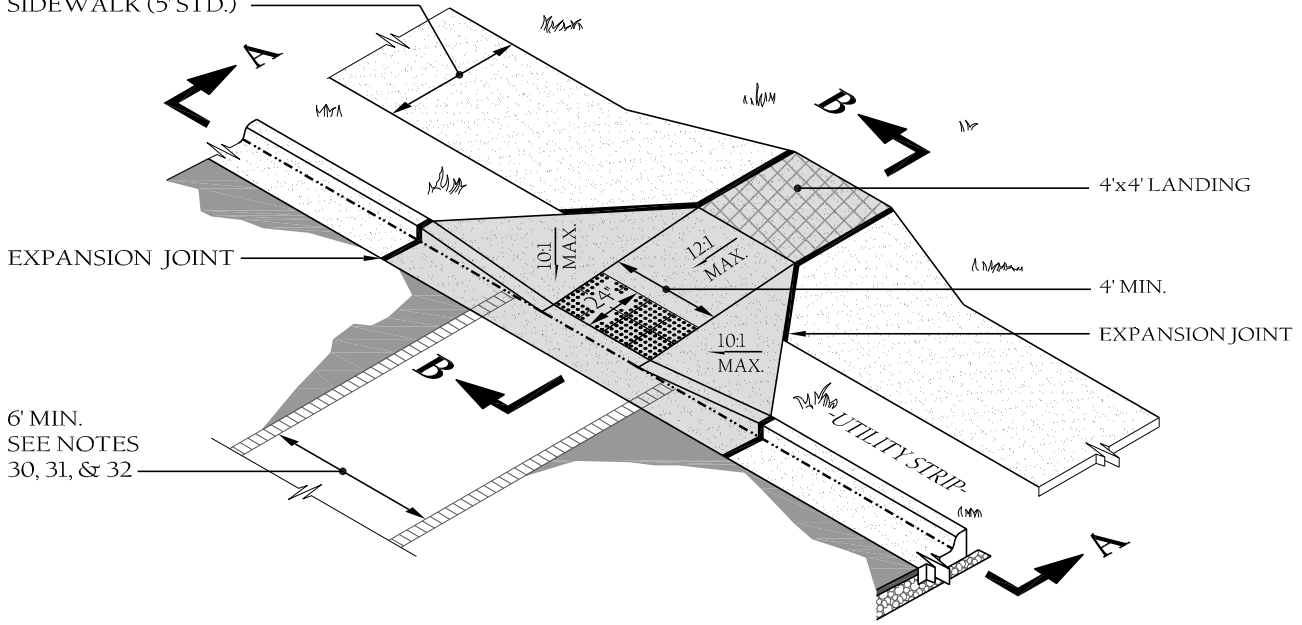

SECTION A-A

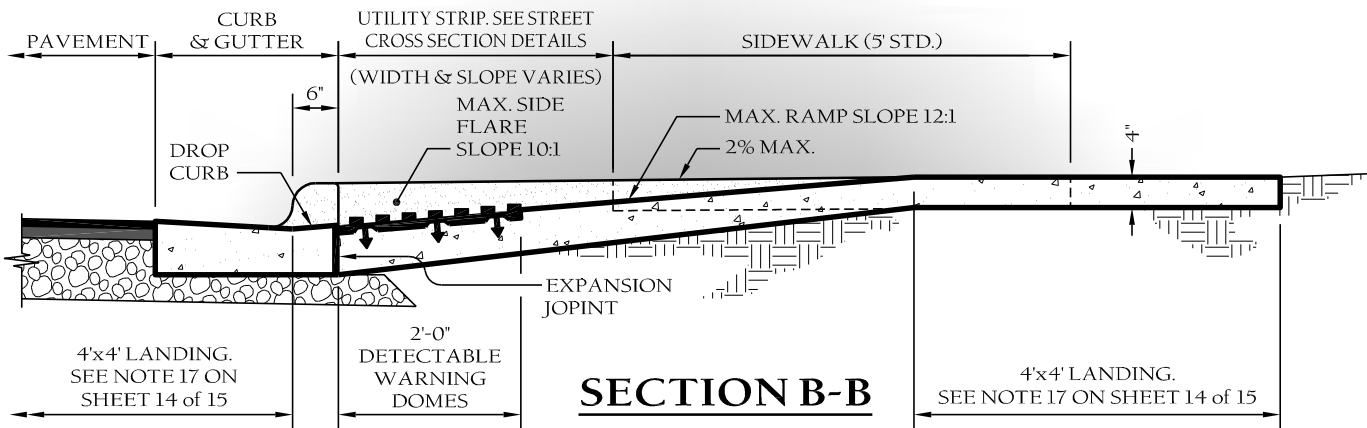

SECTION B-B

NOTES:

1. Detectable warning domes will cover 2'-0" length and full width of the ramp floor as shown on sheet 13 of 15.



TOWN of WAKE FOREST, NC
Manual of Specifications, Standards and Design

**SINGLE CURB RAMP
WITH PROPOSED CURB & GUTTER**

Scale:
Not To Scale

Detail #:
9.13

Revision Date:
Feb., 2015

Sheet #:
4 of 15

ISOMETRIC VIEW

PAY LIMITS FOR CURB RAMP

DETECTABLE WARNING SURFACE. SEE SHEET 13 of 15

6"x12" CONCRETE CURB

NON-WALK SURFACE

EXPANSION JOINT WHERE NEW CONC ABUTS EX. CONCRETE (TYPICAL)

EX. CURB & GUTTER

4'x4' LANDING. SEE NOTE 3 ON THIS SHEET

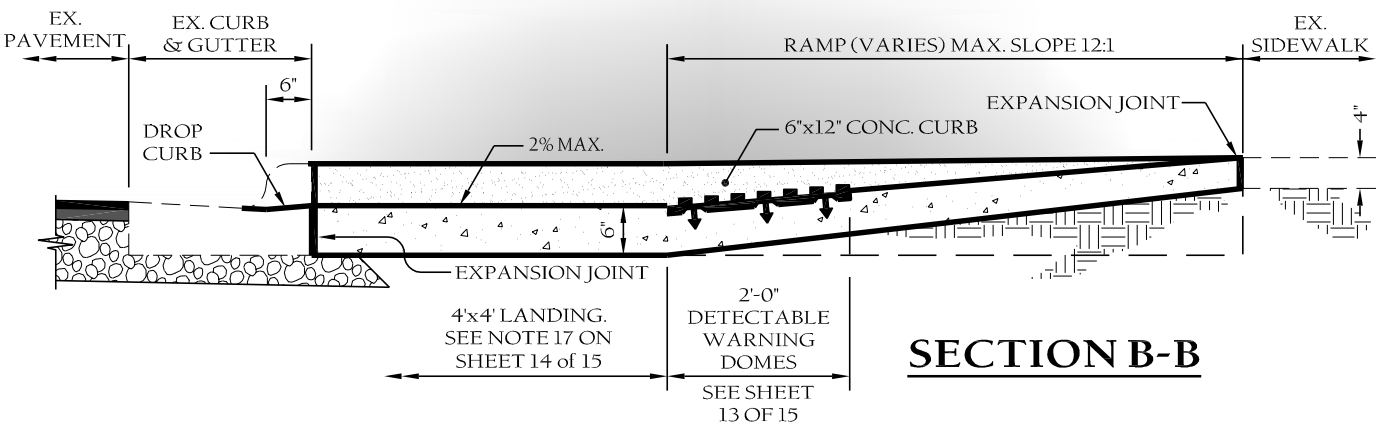
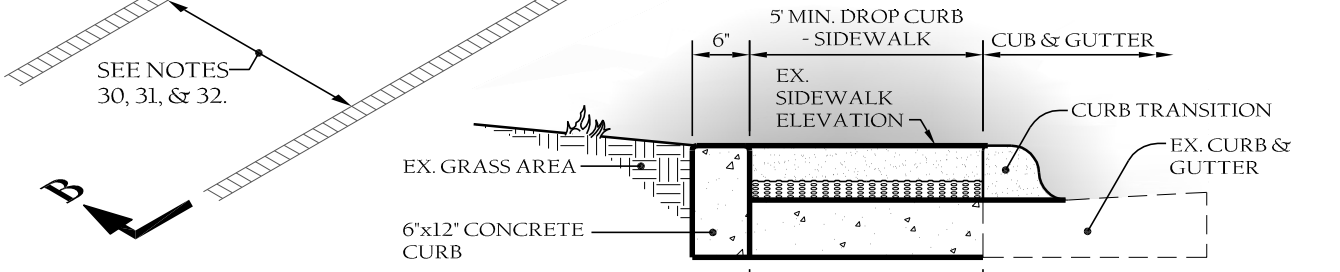

NOTES:

1. Maximum curb ramp slope 8.33% (12:1)
2. Maximum cross slope 2.00%
3. Curb ramps require a (4'-0") minimum landing with a maximum cross slope and longitudinal slope of 2.00% where pedestrians perform turning maneuvers. Slope to drain to curb.
4. Detectable warning domes will cover 2'-0" length and full width of the ramp floor as shown on sheet 13 of 15.
5. Refer to sheet 14 & 15 of 15 for all ramp notes. Adopted from NCDOT Alternate Curb Ramp Details.



TOWN of WAKE FOREST, NC

Manual of Specifications, Standards and Design

CURB RAMPS - DIRECTIONAL TYPE I

Scale: Not To Scale	Detail #: 9.13
Revision Date: Feb., 2015	Sheet #: 5 of 15

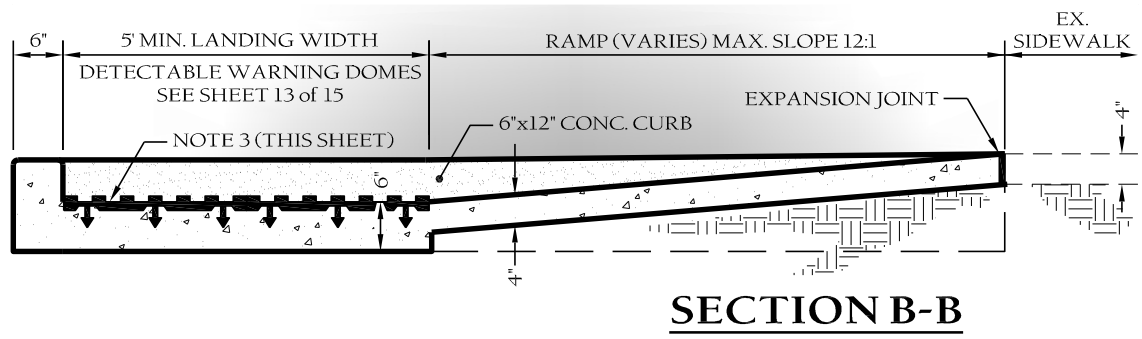
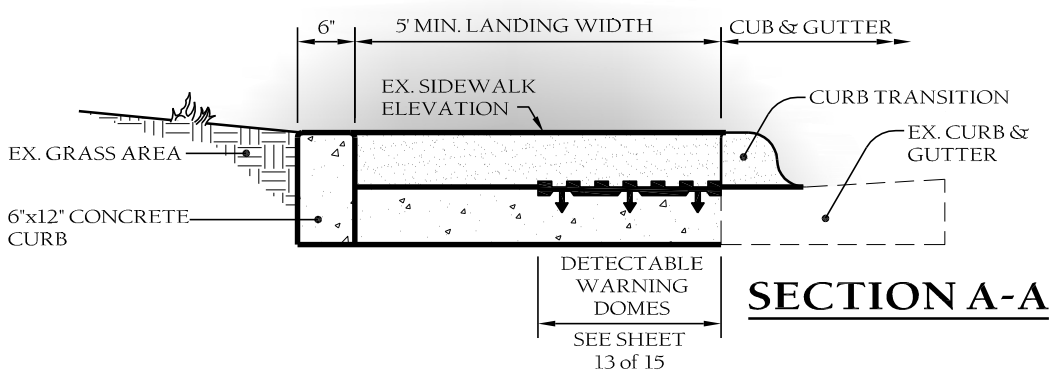
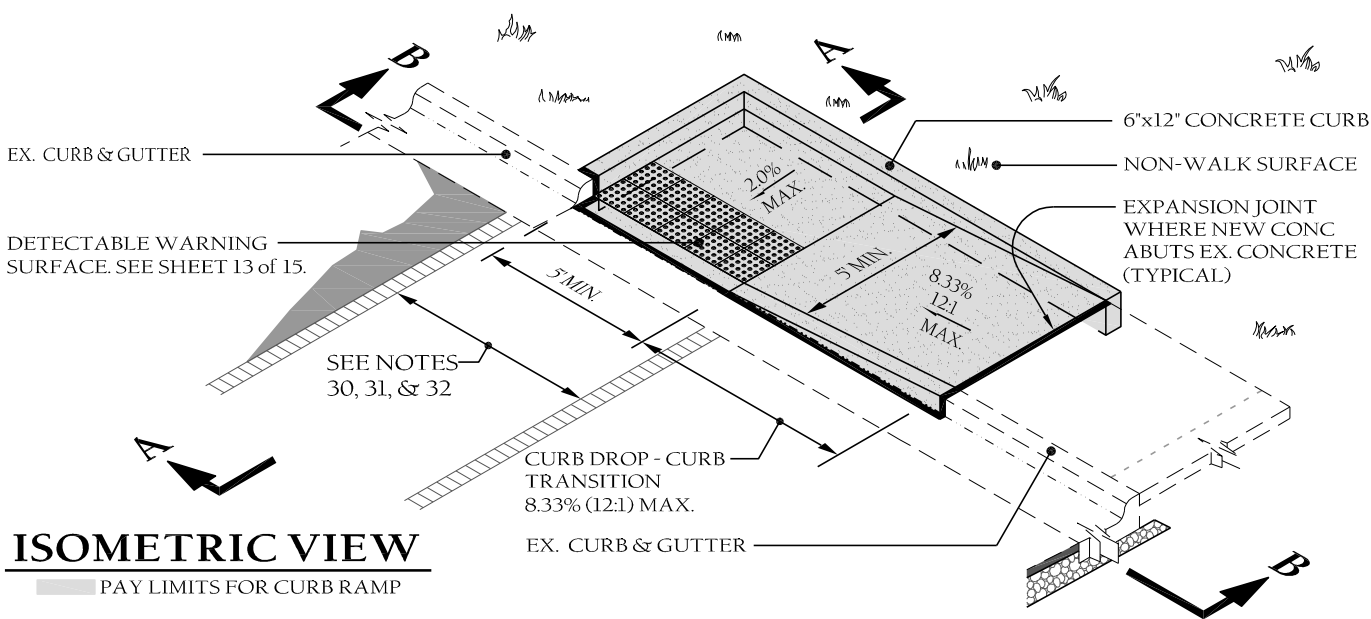

NOTES:

1. Maximum curb ramp slope 8.33% (12:1)
2. Maximum cross slope 2.00%
3. Curb ramps require a (4'-0") minimum landing with a maximum cross slope and longitudinal slope of 2.00% where pedestrians perform turning maneuvers. Slope to drain to curb.
4. Detectable warning domes will cover 2'-0" length and full width of the ramp floor as shown on sheet 13 of 15.
5. Refer to sheet 14 & 15 of 15 for all ramp notes. Adopted from NCDOT Alternate Curb Ramp Details.



TOWN of WAKE FOREST, NC
Manual of Specifications, Standards and Design

CURB RAMPS - DIRECTIONAL TYPE IA

Scale: Not To Scale	Detail #: 9.13
Revision Date: Feb., 2015	Sheet #: 6 of 15

ISOMETRIC VIEW

PAY LIMITS FOR CURB RAMP

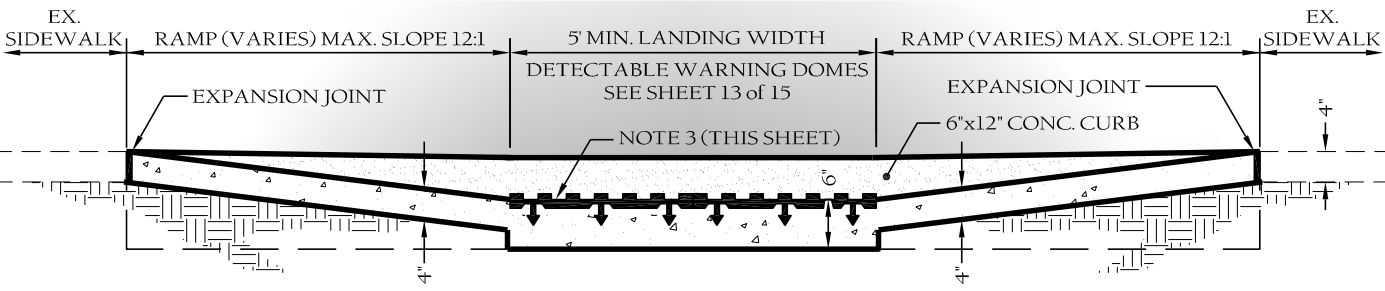
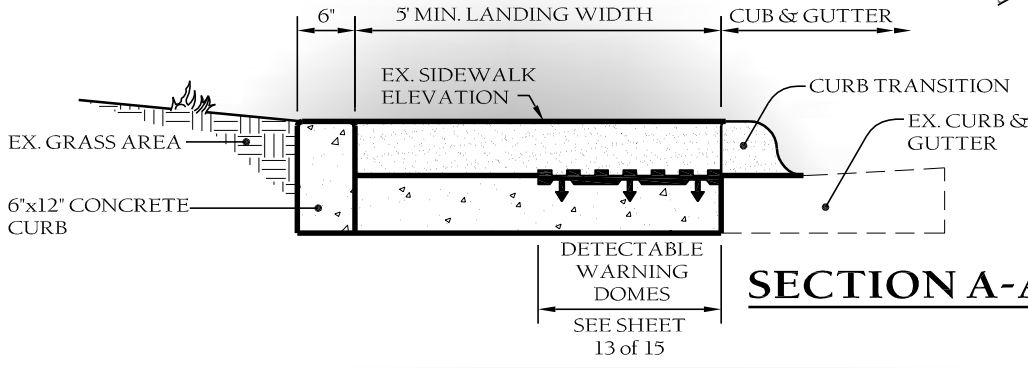
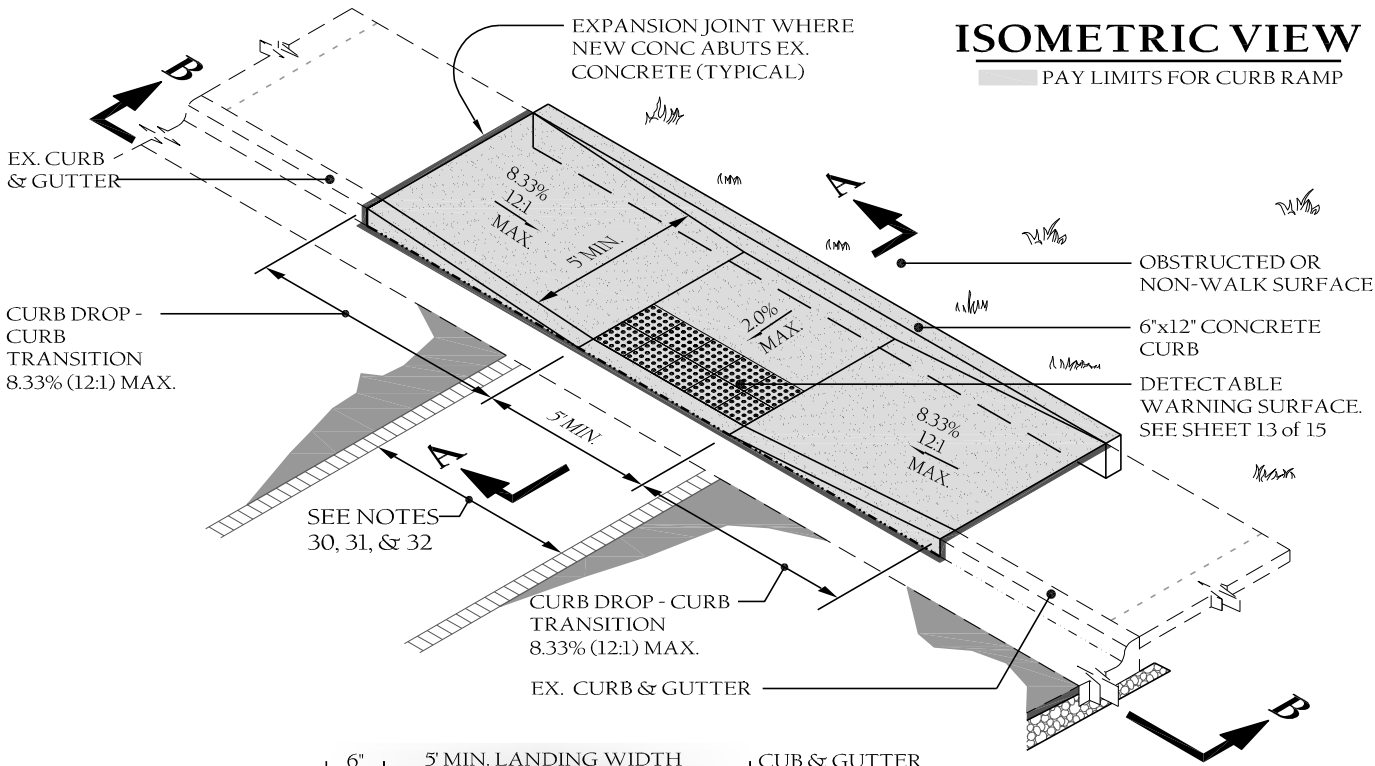

NOTES:

1. Maximum curb ramp slope 8.33% (12:1)
2. Maximum cross slope 2.00%
3. Curb ramps require a (4'-0") minimum landing with a maximum cross slope and longitudinal slope of 2.00% where pedestrians perform turning maneuvers. Slope to drain to curb.
4. Detectable warning domes will cover 2'-0" length and full width of the ramp floor as shown on sheet 13 of 15.
5. Refer to sheet 14 & 15 of 15 for all ramp notes. Adopted from NCDOT Alternate Curb Ramp Details.



TOWN of WAKE FOREST, NC

Manual of Specifications, Standards and Design

CURB RAMPS - DIRECTIONAL TYPE 2

Scale: Not To Scale	Detail #: 9.13
Revision Date: Feb., 2015	Sheet #: 7 of 15

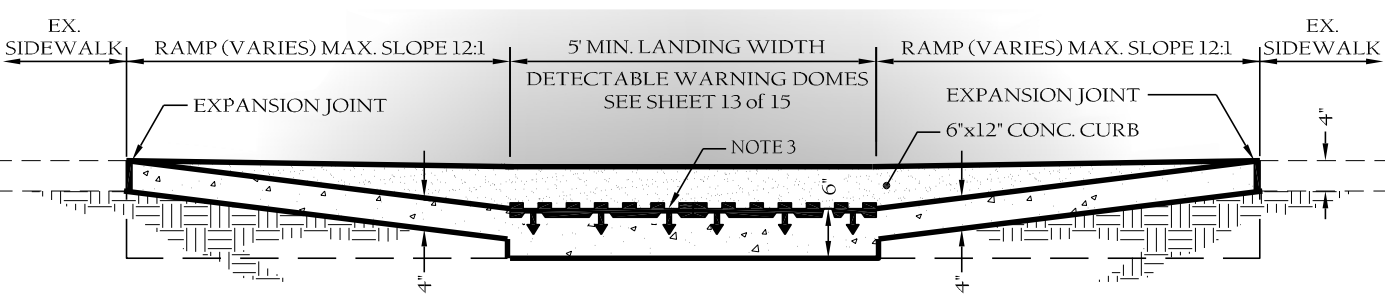
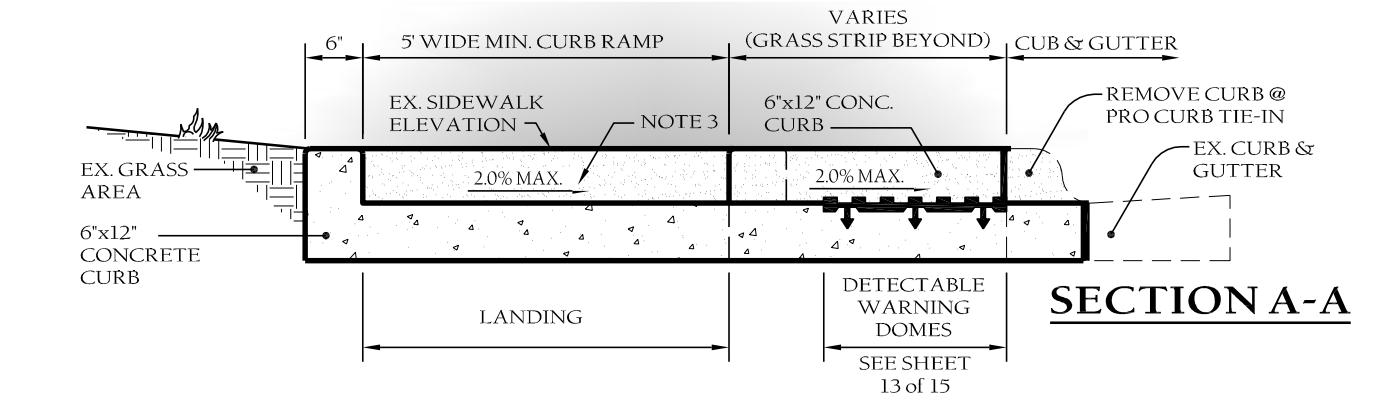
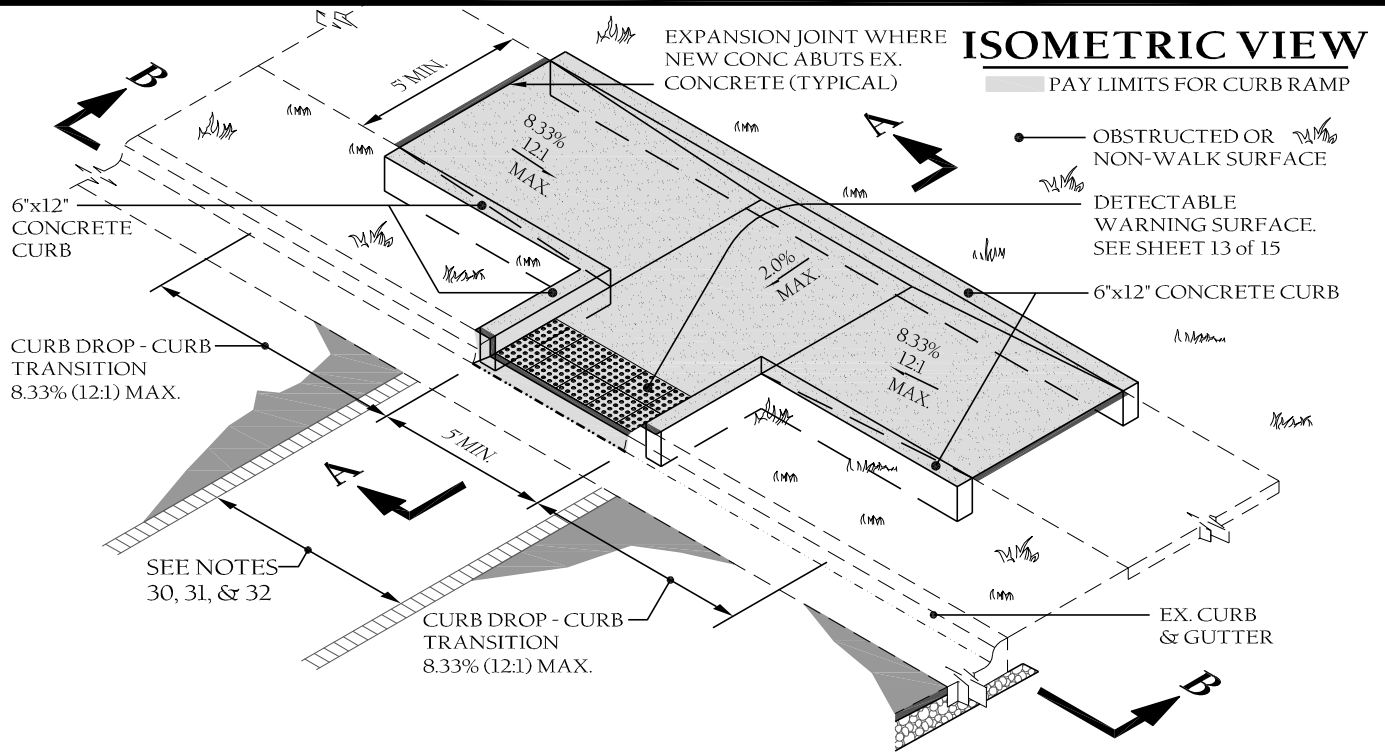

NOTES:

1. Maximum curb ramp slope 8.33% (12:1)
2. Maximum cross slope 2.00%
3. Curb ramps require a (4'-0") minimum landing with a maximum cross slope and longitudinal slope of 2.00% where pedestrians perform turning maneuvers. Slope to drain to curb.
4. Detectable warning domes will cover 2'-0" length and full width of the ramp floor as shown on sheet 13 of 15.
5. Refer to sheet 14 & 15 of 15 for all ramp notes. Adopted from NCDOT Alternate Curb Ramp Details.



TOWN of WAKE FOREST, NC
Manual of Specifications, Standards and Design

CURB RAMPS - DIRECTIONAL
TYPE 3

Scale: Not To Scale	Detail #: 9.13
Revision Date: Feb., 2015	Sheet #: 8 of 15

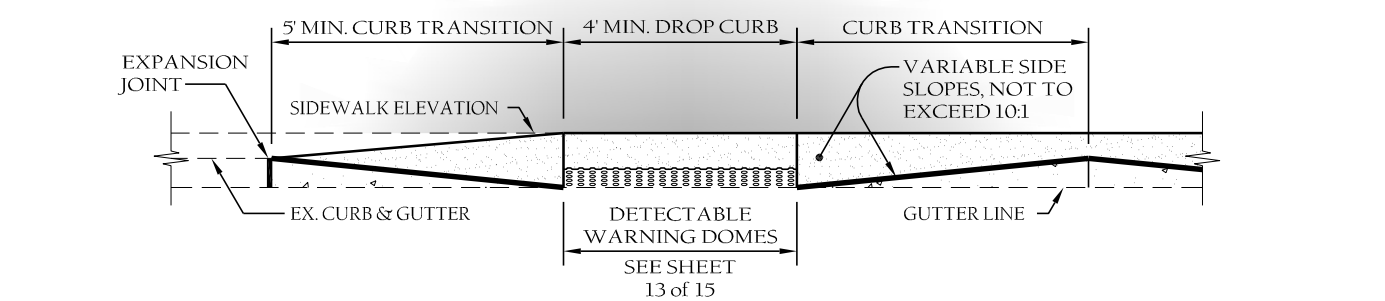
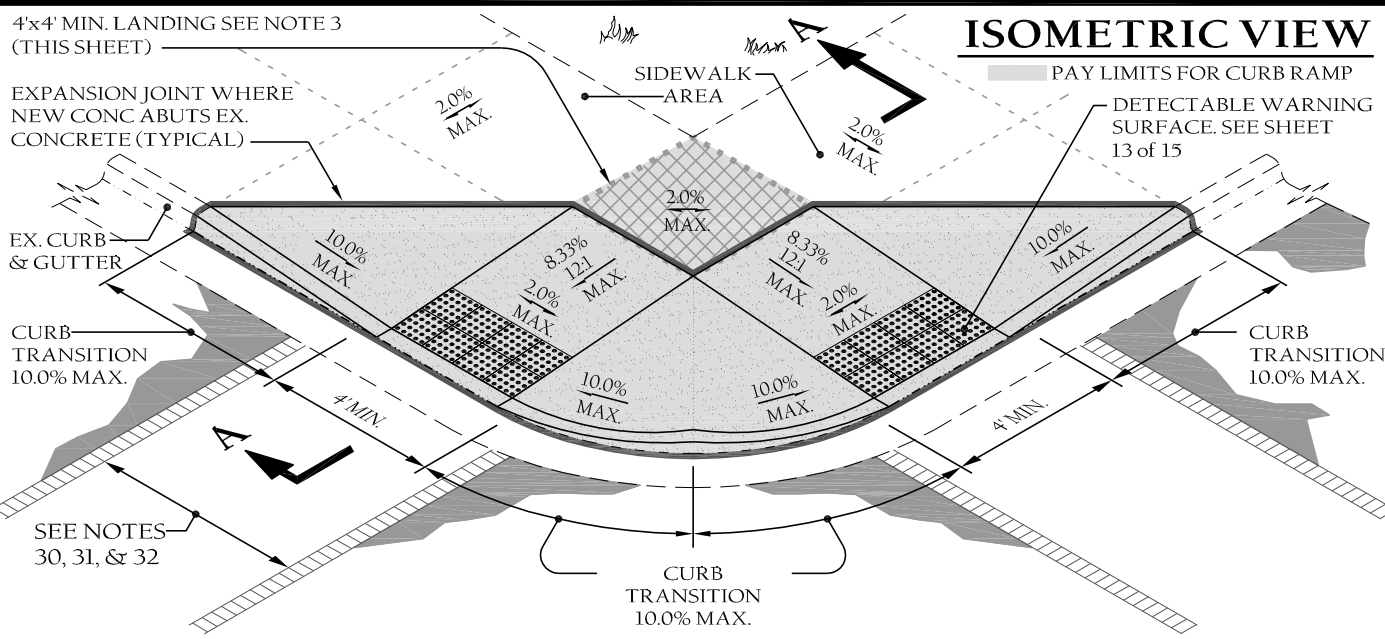

PARTIAL CURB ELEVATION

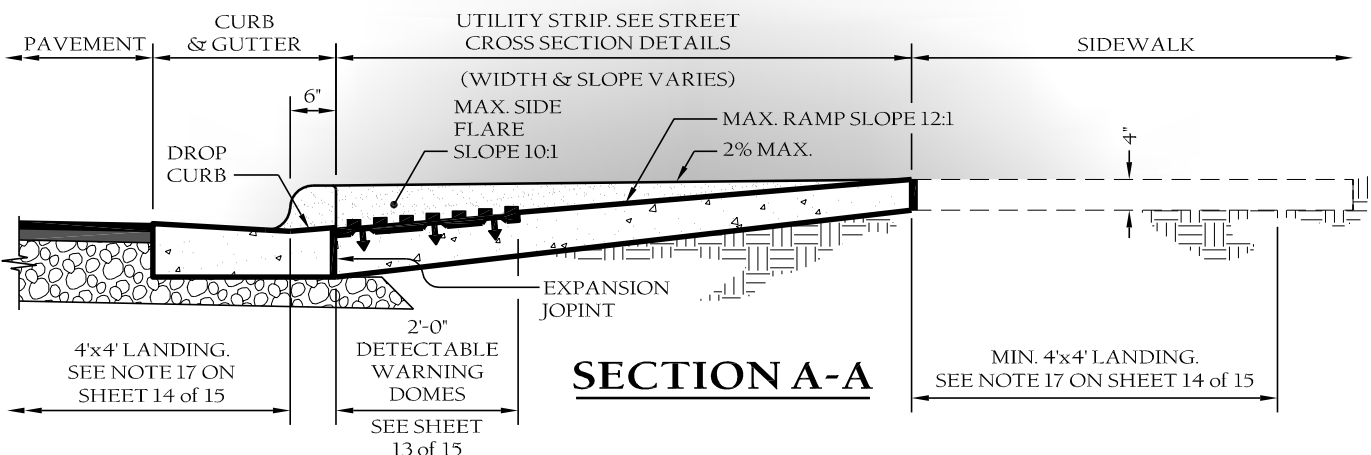

SECTION A-A

NOTES:

1. Maximum curb ramp slope 8.33% (12:1)
2. Maximum cross slope 2.00%
3. Curb ramps require a (4'-0") minimum landing with a maximum cross slope and longitudinal slope of 2.00% where pedestrians perform turning maneuvers. Slope to drain to curb.
4. Detectable warning domes will cover 2'-0" length and full width of the ramp floor as shown on sheet 13 of 15.
5. Refer to sheet 14 & 15 of 15 for all ramp notes. Adopted from NCDOT Alternate Curb Ramp Details.



TOWN of WAKE FOREST, NC
Manual of Specifications, Standards and Design

CURB RAMPS - SHARED LANDING
TYPE 4

Scale: Not To Scale	Detail #: 9.13
Revision Date: Feb., 2015	Sheet #: 9 of 15

ISOMETRIC VIEW

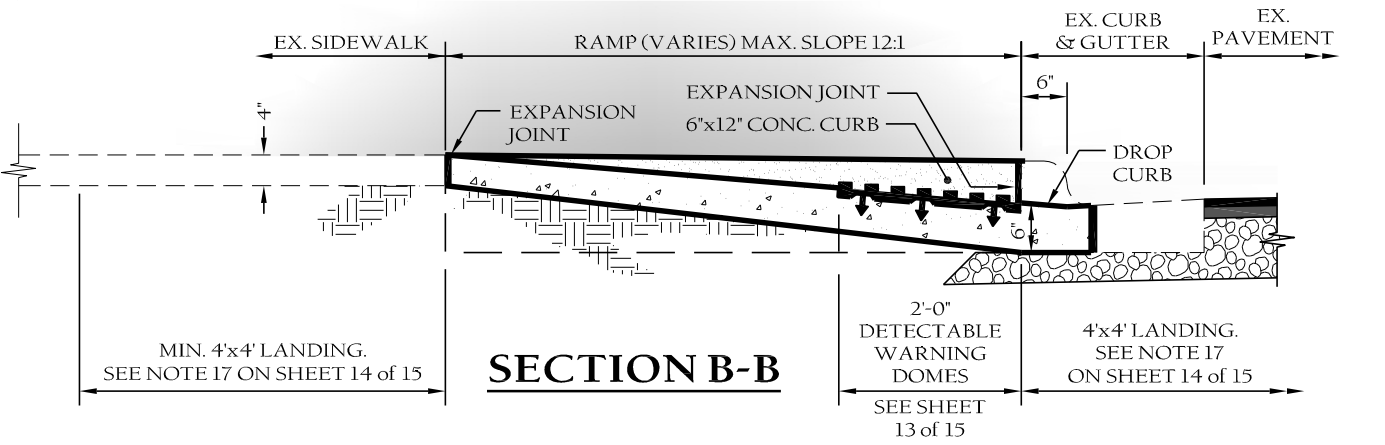
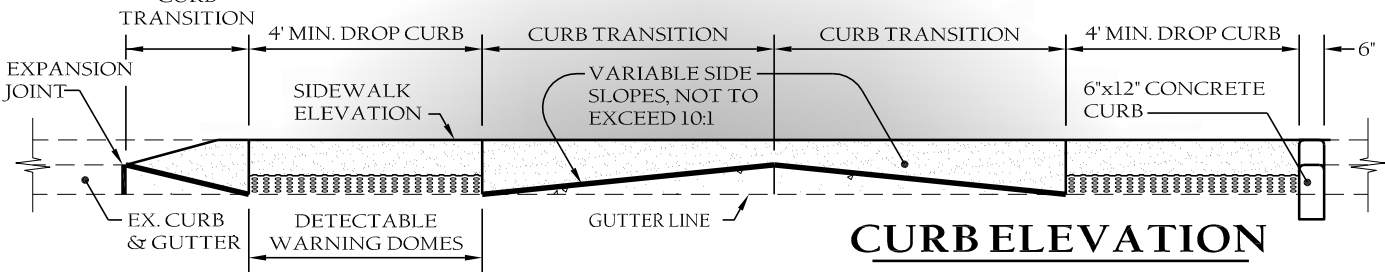
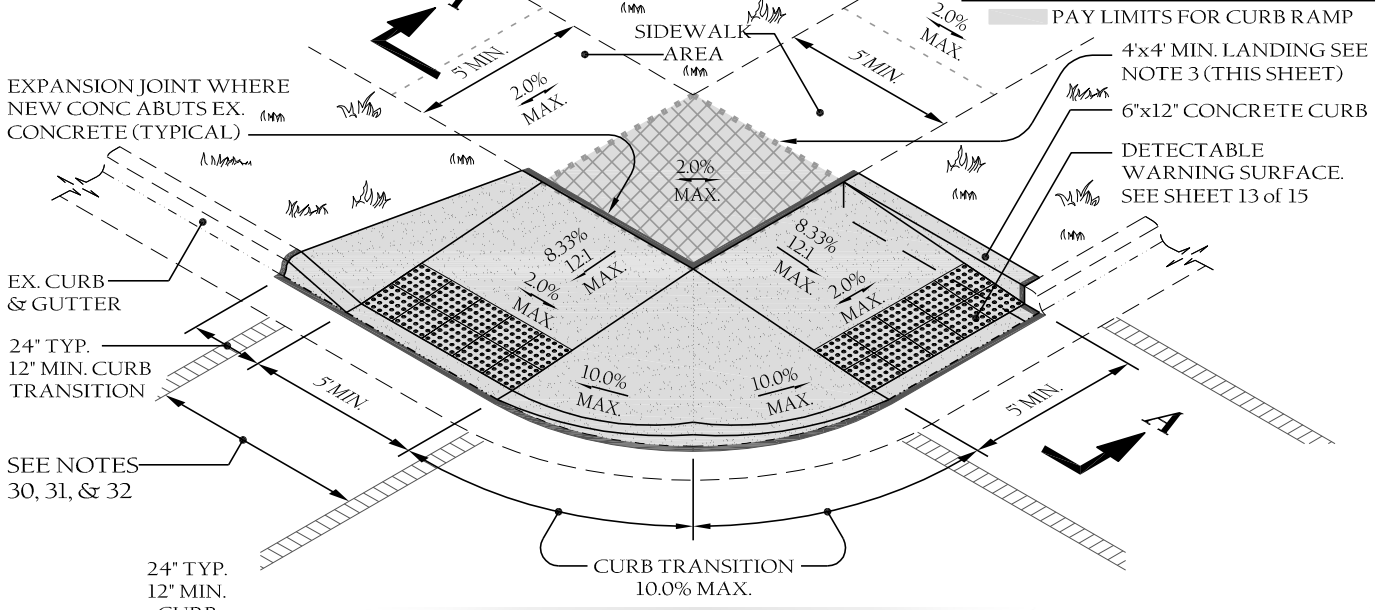

NOTES:

1. Maximum curb ramp slope 8.33% (12:1)
2. Maximum cross slope 2.00%
3. Curb ramps require a (4'-0") minimum landing with a maximum cross slope and longitudinal slope of 2.00% where pedestrians perform turning maneuvers. Slope to drain to curb.
4. Detectable warning domes will cover 2'-0" length and full width of the ramp floor as shown on sheet 13 of 15.
5. Refer to sheet 14 & 15 of 15 for all ramp notes. Adopted from NCDOT Alternate Curb Ramp Details.



TOWN of WAKE FOREST, NC

Manual of Specifications, Standards and Design

CURB RAMPS - SHARED LANDING

TYPE 4A

Scale: Not To Scale	Detail #: 9.13
Revision Date: Feb., 2015	Sheet #: 10 of 15

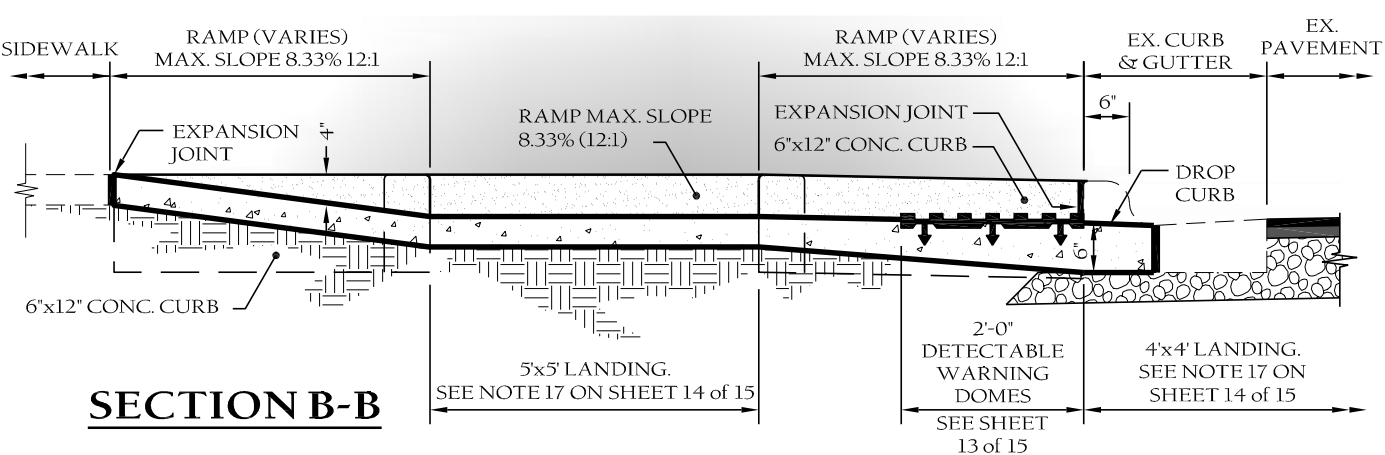
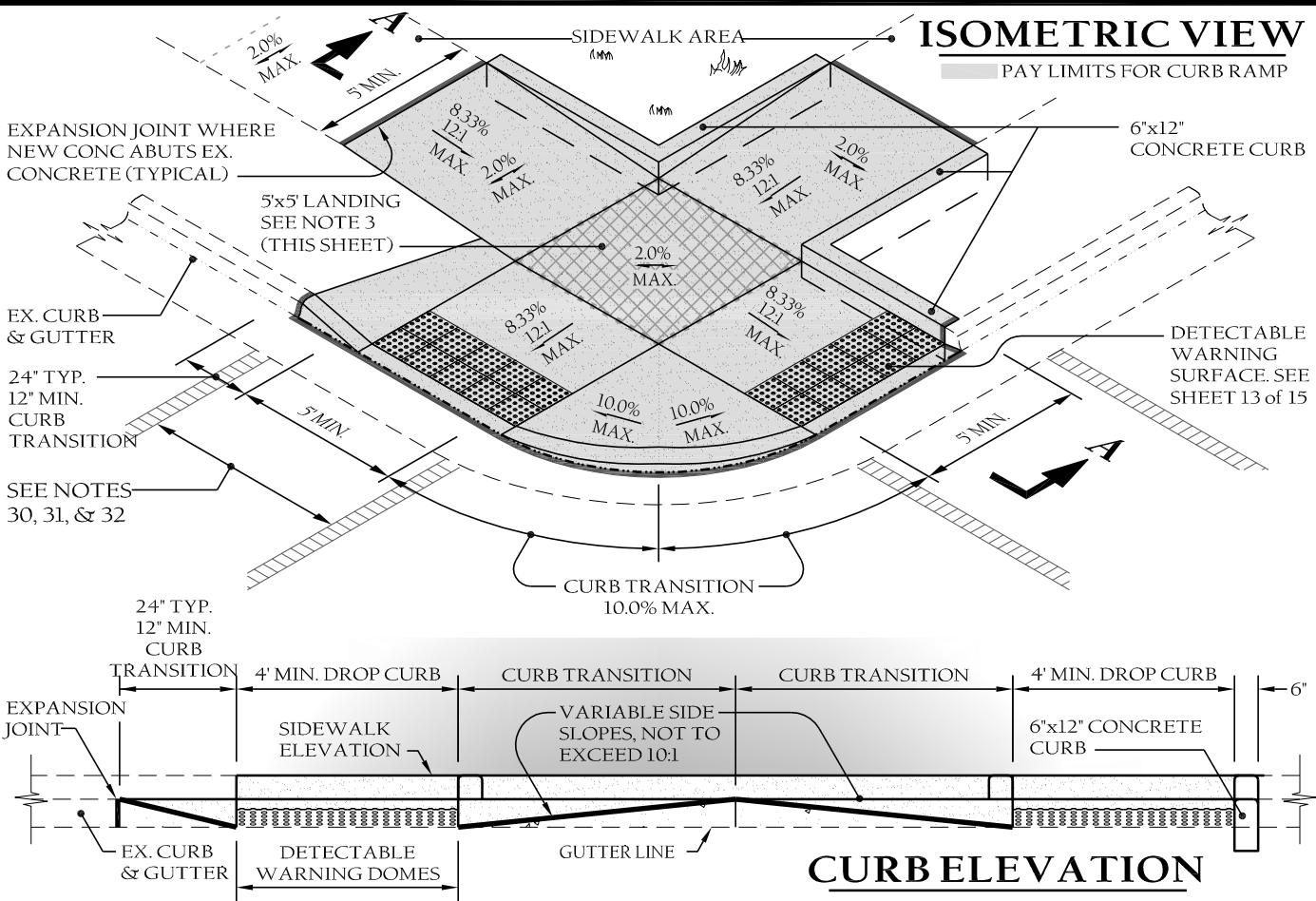

NOTES:

1. Maximum curb ramp slope 8.33% (12:1)
2. Maximum cross slope 2.00%
3. Curb ramps require a (4'-0") minimum landing with a maximum cross slope and longitudinal slope of 2.00% where pedestrians perform turning maneuvers. Slope to drain to curb.
4. Detectable warning domes will cover 2'-0" length and full width of the ramp floor as shown on sheet 13 of 15.
5. Refer to sheet 14 & 15 of 15 for all ramp notes. Adopted from NCDOT Alternate Curb Ramp Details.



TOWN of WAKE FOREST, NC
 Manual of Specifications, Standards and Design

CURB RAMPS - SHARED LANDING
TYPE 5

Scale: Not To Scale	Detail #: 9.13
Revision Date: Feb., 2015	Sheet #: 11 of 15

PAY LIMITS FOR CURB RAMP

TRIANGULAR ISLAND WITH CUT THROUGH

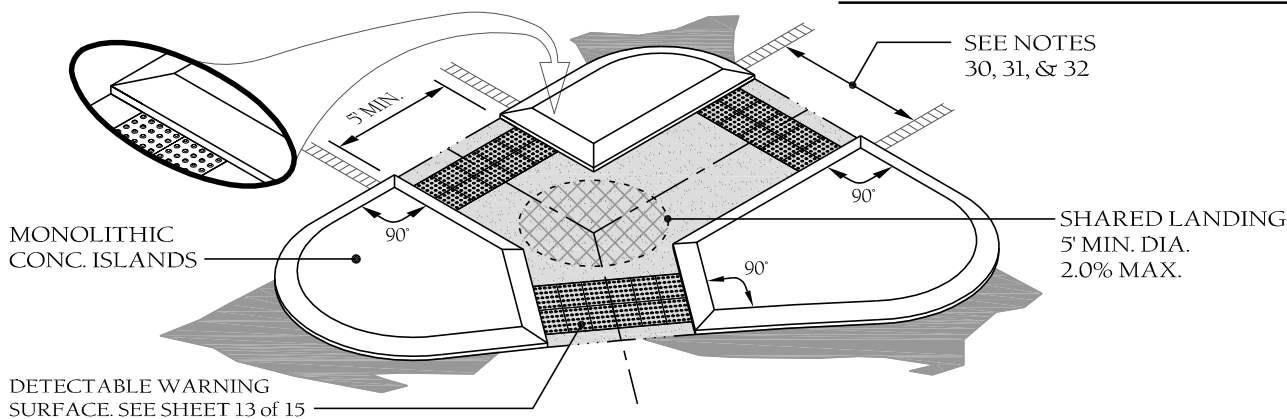

MEDIAN ISLAND WITH CUT THROUGH

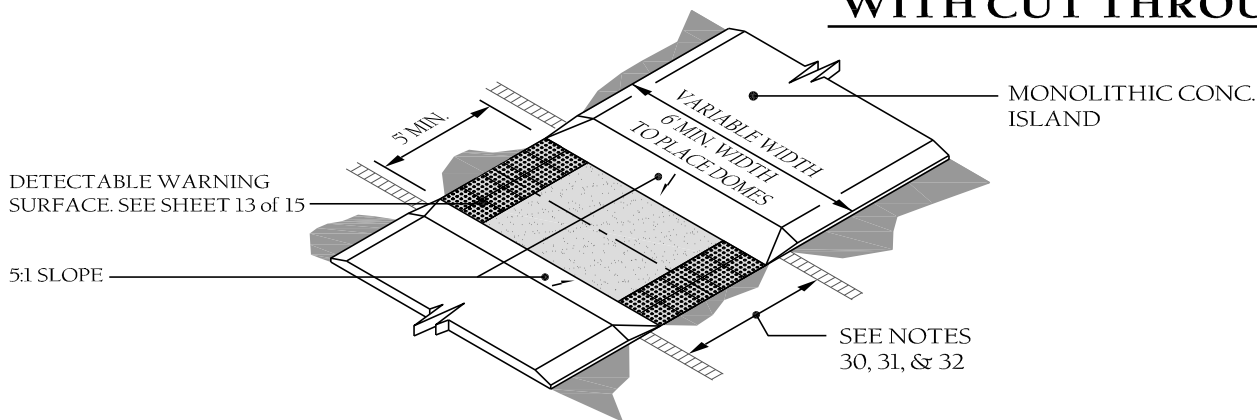

MEDIAN ISLAND WITH CURB RAMPS

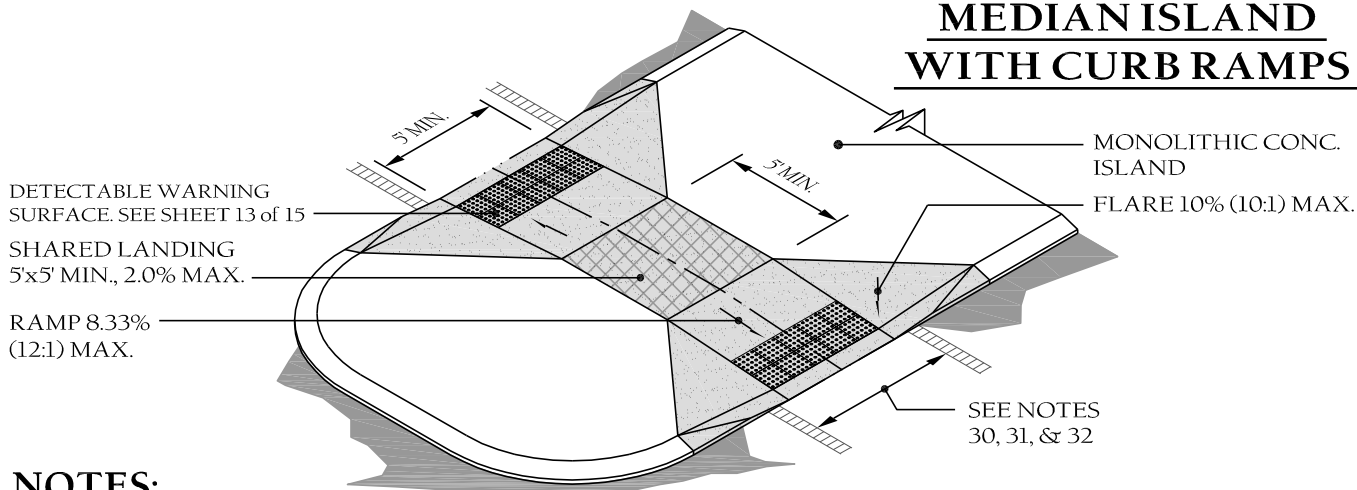

NOTES:

1. Maximum curb ramp slope 8.33% (12:1)
2. Maximum cross slope 2.00%
3. Detectable warning domes will cover 2'-0" length and full width of the ramp floor as shown on sheet 13 of 15.
4. See NCDOT Roadway Std. Drawing 852.01 for concrete island dimensions.



TOWN of WAKE FOREST

TOWN of WAKE FOREST, NC
Manual of Specifications, Standards and Design

CURB RAMPS
MEDIAN ISLANDS

Scale:
Not To Scale

Detail #:
9.13

Revision Date:
Feb., 2015

Sheet #:
12 of 15

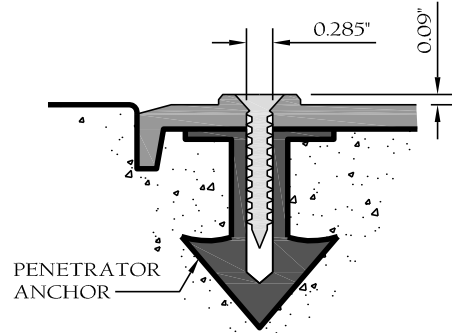
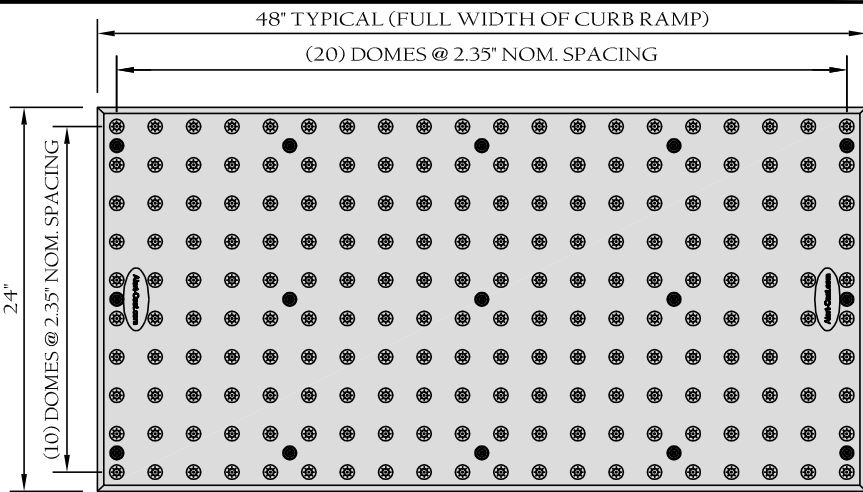

PENETRATOR SECTION

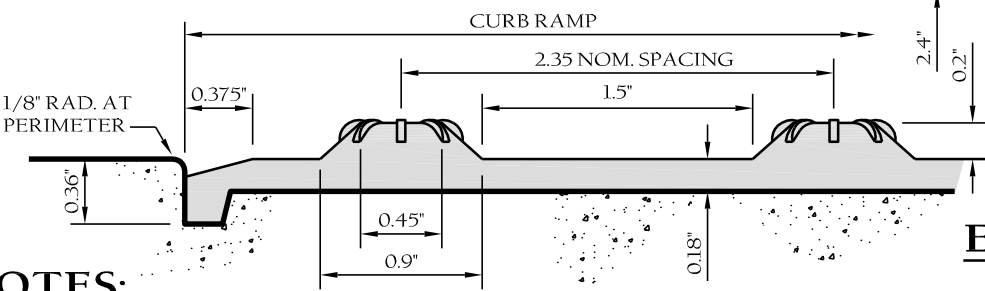
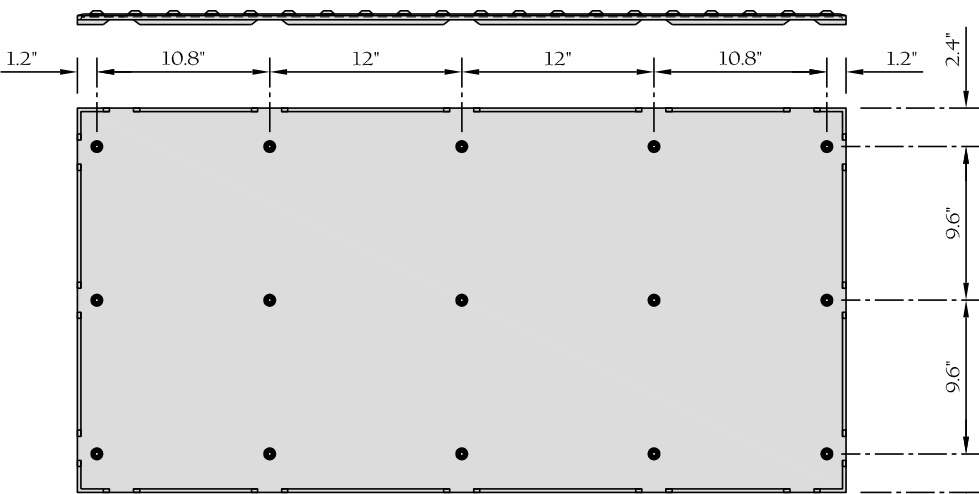

END SECTION

NOTES:

1. Detectable warning System. Cast in place with Penetrator anchors. See pre-approved products list.
2. Other sizes available to meet site specific requirements. Verify with Town.
3. Truncated domes in a detectable warning surface shall have a base diameter of 0.9 inch minimum to 1.4 inches maximum, a top diameter of 50% of the base diameter minimum to 65% of the base diameter maximum, and a height of 0.2 inches.
4. Truncated domes in a detectable warning surface shall have a center-to-center spacing of 1.6 inches minimum and 2.4 inches maximum, and a base-to-base spacing of 0.65 inches minimum, measured between the most adjacent domes on square grid.
5. Detectable warning surfaces shall extend 24 inches minimum in the direction of travel and the full width of the curb ramp, landing, or blended transition. The edge nearest the curb line shall be a minimum of 6 inches and a maximum of 8 inches from curb (ICC/ANSI A117.1 Fig C406.13.2). See notes 21 & 22.
6. See note 23, sheet 5.
7. Any NCDOT street must conform to DOT standard/ADA Curb Ramp detail 848.05 sheet 1-4.



TOWN of WAKE FOREST, NC
Manual of Specifications, Standards and Design

STANDARD DETECTABLE WARNING SYSTEM

Scale: Not To Scale	Detail #: 9.13
Revision Date: Feb., 2015	Sheet #: 13 of 15

STANDARD NOTES:

1. North Carolina General Statute 136-44.14 requires that all street curbs being constructed or reconstructed for maintenance procedures, traffic operations, repairs, correction of utilities or altered for any reason after September 1, 1973 shall provide curb ramps for the physically disabled at all intersections where both curb and gutter and sidewalks are provided and at other points of pedestrian flow.
In addition, section 228 of the 1973 Federal Aid Highway Safety Act requires provision of curb ramps on any curb construction after July 1, 1976 whether a sidewalk is proposed initially or is planned for a future date.
The Americans with Disability Act (ADA) of 1990 extends to individuals with disabilities. Comprehensive civil rights protections similar to those provided to persons on the basis of race, sex, national origin and religion under the Civil Rights Act of 1964. These curb ramps have been designed to comply with the current ADA standards (2010 ADA Standards for Accessible Design, dated September 15, 2010 & effective March 15, 2012).
2. Curb ramps are required when streets are altered for resurfacing (spanning one intersection to another and includes overlay of additional material to the road surface with or without milling), reconstructed, rehabilitated or widened. Maintenance activities on streets, such as crack filling sealing, pavement markings, surface sealing and pavement patching, are not alterations. However, if there is no block-to-block resurfacing but resurfacing is occurring at a crosswalk itself, partial resurfacing (curb-to-curb resurfacing of a crosswalk) requires the provision of curb ramps at that crosswalk.
Curb ramps are not required in the absence of a pedestrian walkway with a prepared surface nor are curb ramps required in the absence of curb, elevation or other barrier between the street and the walkway. [USDOJ July 8, 2013]
3. Curb ramps are required at all curb returns.
4. Detectable warning domes are required for curb ramps.
5. Single curb ramp at the center of the return are not permitted.
6. Dimensions assume 90° centerline intersection of streets.
7. Construct the ramp surface to be stable, firm and slip resistant. Located and construct the curb ramp type as shown in these details.
8. Curb ramps shall be constructed perpendicular to the roadway travel lane.
9. Coordinate the curb ramp and pedestrian crosswalk markings so a 4'x4' clear space at the base of the curb ramp will fall within the pedestrian crosswalk lines.
10. Set back distance from inside corner of an intersection crosswalk marking to nearest edge of travel lane is 4 feet minimum.
11. Terminate parking a minimum of 20 feet back of a pedestrian crosswalk.
12. Construct a curb ramps a minimum of 4 feet wide. Width may exceed 48".
13. Construct the running slope of the ramp at a maximum of 8.33% (1 : 12).
14. Allowable cross slope on sidewalks and ramps to be a maximum of 2%.
15. Construct the side flare slope to a maximum of 10% measured along the curb line.;
16. Construct the counter-slope of the gutter or street at the base of the curb ramp at a maximum of 5% and maintain a smooth transition.
17. Construct landings for sidewalk at a minimum of 4'x4' with a maximum slope of 2% in any direction. Construct landings for median islands a minimum of 5'x5' with a maximum slope of 2% in any direction.
18. To use a median island as a pedestrian refuge area, median islands will be a minimum of 6 feet wide. Construct median islands to provide passage over or through the island.
19. Small channelization islands that cannot provide a 5'x5' landing at the top of a curb ramp, will be cut through level with the surface of the street.
20. Curb ramps with returned side curbs may be used only where pedestrians would not normally walk across the ramp such as where there the adjacent surface is plantings, other non-walking surface, or the side approach is substantially obstructed.
21. The typical 2'x4' truncated dome pad shall be placed with the short dimension perpendicular to the curb. See curb ramp typical details. Truncated dome pads shall abutt the back of the curb (ICC/ANSI A117.1 Fig C406.13.2).
22. Curved truncated dome pads are permitted when ramp width is greater than 4 feet.
23. Color contrast required only when detectable warning plates are employed. (ADA Standards for Accessible Design, section 705, Latest Edition). Recommended Min. light reflectance contrast is 70% (American National Standard ICC/ANSI A117.1 - Standard & Commentary Section 705.3, Latest Edition). Painted surface will not be acceptable. (See note 4).
24. Place a 1/2-inch expansion joint where the concrete curb ramp joins/abuts the curb.
25. Curb ramps through median islands, single ramps at dual crosswalks or limited right-of-way situations will be handled by special details. Consult with the Town Engineer.
26. When construction is on a NCDOT Right-of-Way, construction shall conform to the latest edition of the NCDOT Roadway Standard drawings.
27. Construction of curb ramps shall conform to the latest edition of the ICC/ANSI A117, Chapter 4 Accessible Routes.



TOWN of WAKE FOREST, NC Manual of Specifications, Standards and Design

STANDARD NOTES FOR CURB RAMPS

Scale: Not To Scale	Detail #: 9.13
Revision Date: Feb., 2015	Sheet #: 14 of 15

STANDARD NOTES (continued):

28. Curb ramps shall be provided at locations as shown on these plans or as directed by the engineer. Curb ramps shall be located as indicated in these details; however, the location may be adjusted as directed by the engineer where existing light poles, fire hydrants, drop inlets, etc. Affect placement. At these locations, not less than 2 feet of full height curb shall be placed between adjacent ramps.
29. Use air entrained 3000 psi concrete with a sidewalk finish in order to obtain a rough non-skid type surface.
30. Crosswalk widths and configuration vary but must conform to traffic design standards.
31. Place the inside pedestrian crosswalk lines no closer in the intersection than would be established by bisecting the intersection radii, with an allowance of a 4'x4' maneuvering space (2003 ICC/ANSI a117 Commentary, Fig. C406.6 & 406.10) in the vehicular travel way when one ramp is installed.
32. Place all pavement markings in accordance with the latest edition of the Manual of Uniform Traffic Control Devices (MUTCD) published by the Federal Highway Administration and the North Carolina Supplement to the MUTCD.
33. For asphalt greenways transition greenway to concrete to enable truncated dome placement.
34. Concrete must come from a ready mix concrete truck to ensure mix meets air entrainment requirements. No site mix or sakrete mix allowed.



TOWN of
WAKE FOREST

TOWN of WAKE FOREST, NC Manual of Specifications, Standards and Design

STANDARD NOTES FOR CURB RAMPS

Scale:
Not To Scale

Detail #:
9.13

Revision Date:
Feb., 2015

Sheet #:
15 of 15



TOWN of
WAKE FOREST

TOWN of WAKE FOREST, NC
Manual of Specifications, Standards and Design

**RESERVED
FUTURE DETAIL**

Scale:
Not To Scale

Detail #:
9.14

Revision Date:
Feb., 2015

Sheet #:
1 of 1

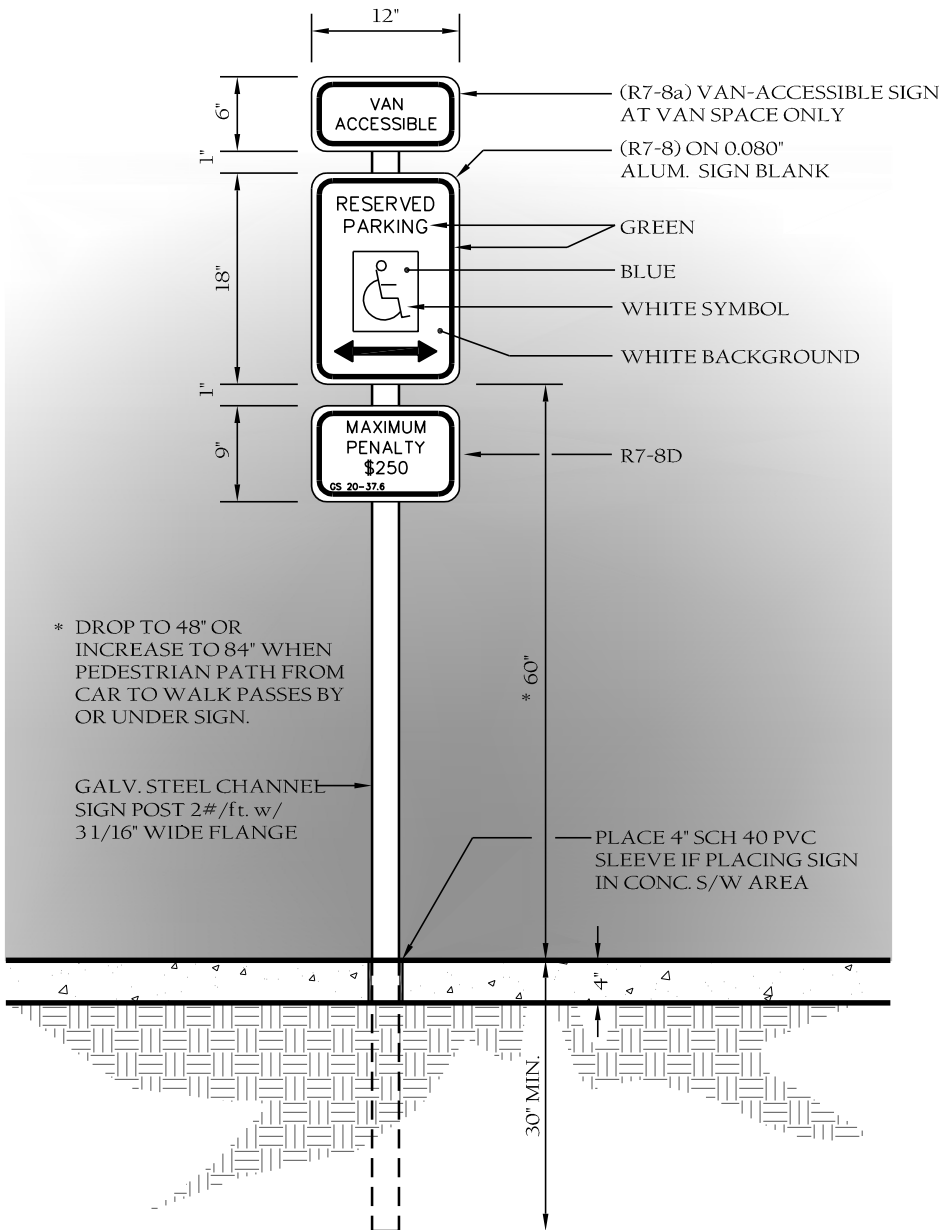

TOWN of WAKE FOREST, NC
Manual of Specifications, Standards and Design

R7-8 HANDICAP SIGN DETAIL

Scale:
Not To Scale

Revision Date:
Feb., 2015

Detail #:
9.15

Sheet #:
1 of 1



DIMENSIONS ARE FROM MEDIAN OR PAINTED CENTERLINE ON SINGLE LANE ROUNDABOUT

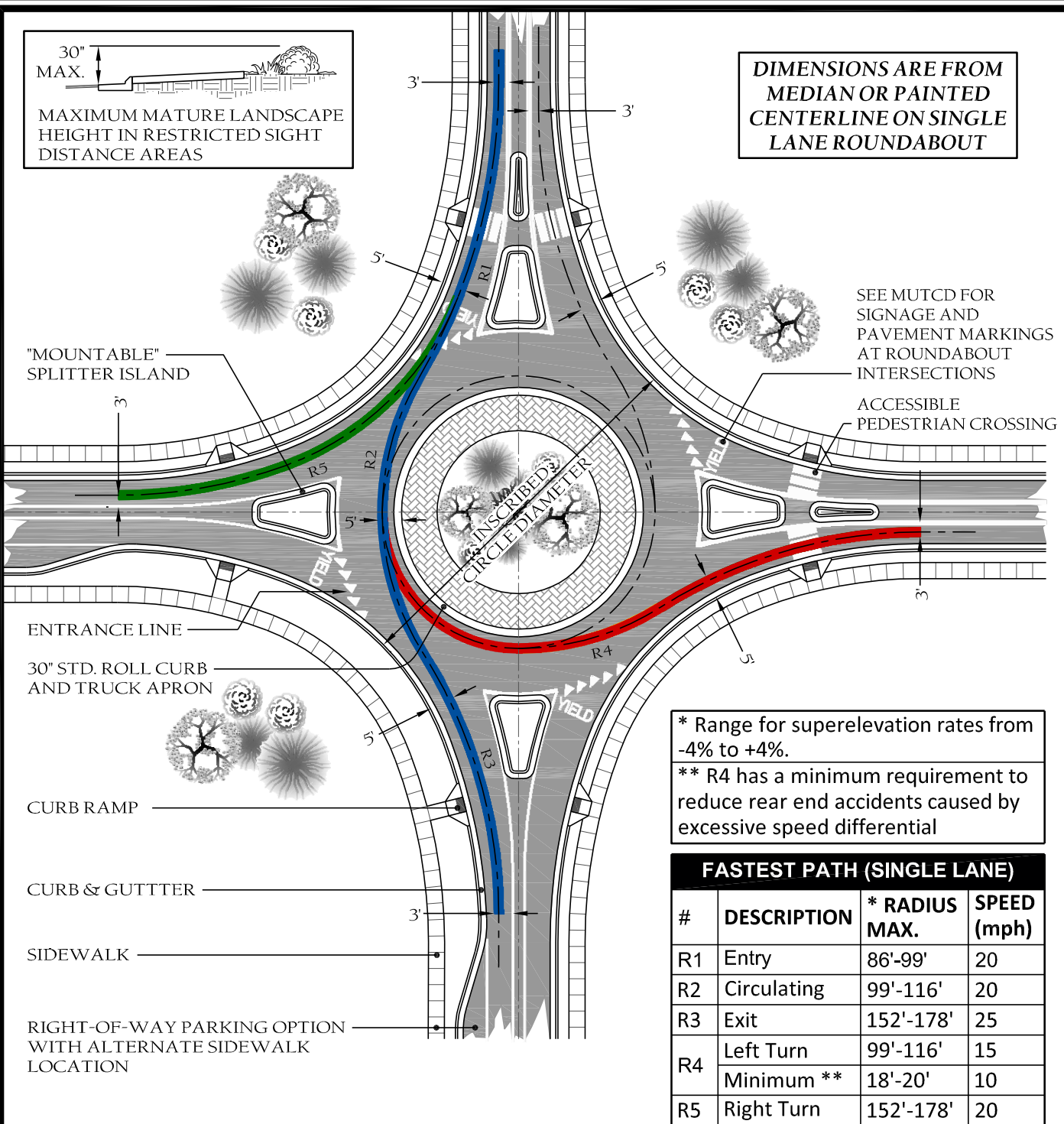

* Range for superelevation rates from -4% to +4%.
** R4 has a minimum requirement to reduce rear end accidents caused by excessive speed differential

FASTEST PATH (SINGLE LANE)			
#	DESCRIPTION	* RADIUS MAX.	SPEED (mph)
R1	Entry	86'-99'	20
R2	Circulating	99'-116'	20
R3	Exit	152'-178'	25
R4	Left Turn	99'-116'	15
	Minimum **	18'-20'	10
R5	Right Turn	152'-178'	20

NOTES:

1. Decision Sight Distance (DSD) and Stopping Sight Distance (SSD) must be checked for horizontal and vertical alignment. DSD & SSD are measured along vehicle path.
2. SSD for pedestrians measured to point 6' behind curb.
3. Refer to the FHWA Technical Summary on Roundabouts for considerations in the design section & implementation of Roundabouts (FHWA-SA-10-006, latest revision).



TOWN of WAKE FOREST, NC
Manual of Specifications, Standards and Design

ROUNDABOUT
STANDARD DETAIL

Scale: Not To Scale	Detail #: 9.16
Revision Date: Feb., 2015	Sheet #: 1 of 2

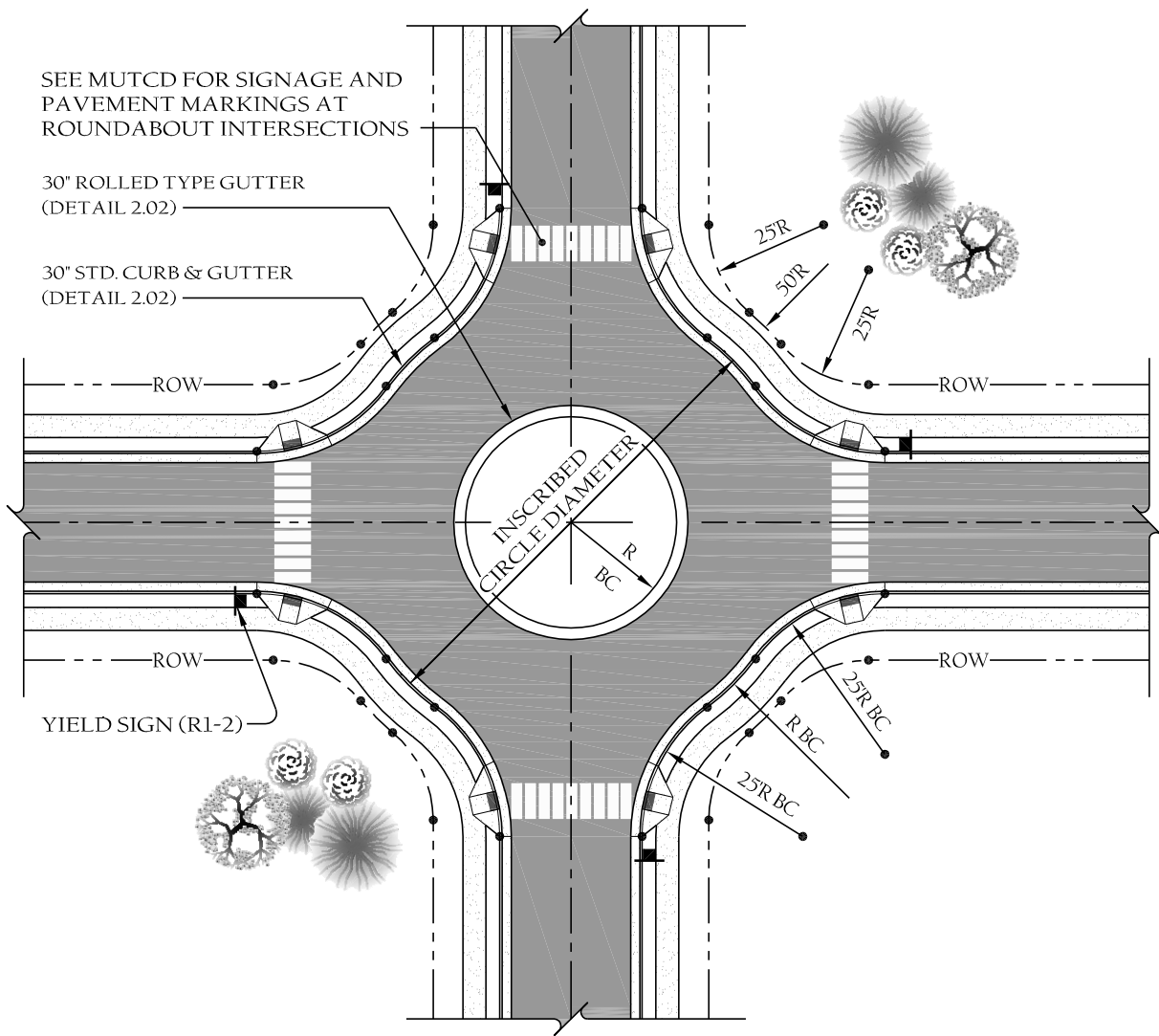

NOTES:

1. Decision Sight Distance (DSD) and Stopping Sight Distance (SSD) must be checked for horizontal and vertical alignment. DSD & SSD are measured along vehicle path.
2. SSD for pedestrians measured to point 6' behind curb.
3. Refer to the FHWA Technical Summary on Roundabouts for considerations in the design section & implementation of Neighborhood Traffic Circles (FHWA-SA-10-006, latest revision).
4. Dimensions shown are minimum and to be verified with a traffic design. Coordinate design with Town Engineer.
5. R1-2 is a MUTCD sign designations (Manual on Uniform Traffic Control Devices.)



TOWN of WAKE FOREST, NC
Manual of Specifications, Standards and Design

**ROUNDABOUT
STANDARD DETAIL**

Scale: Not To Scale	Detail #: 9.16
Revision Date: Feb., 2015	Sheet #: 2 of 2

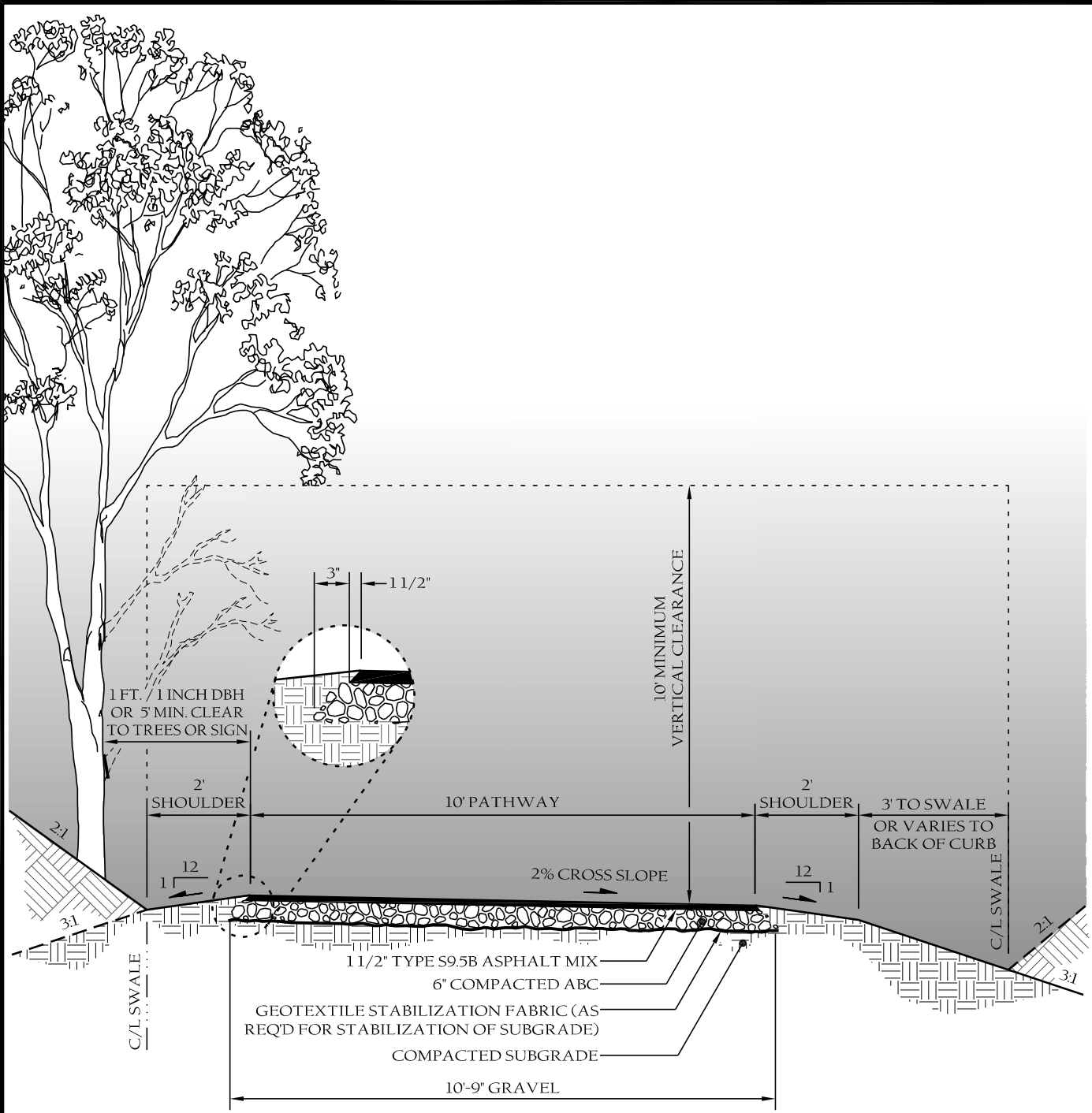

ASPHALT SECTION
PAVED



TOWN of WAKE FOREST, NC
Manual of Specifications, Standards and Design

**MULTI-USE PATH
DETAIL**

Scale: Not To Scale	Detail #: 9.17
Revision Date: Feb., 2015	Sheet #: 1 of 1

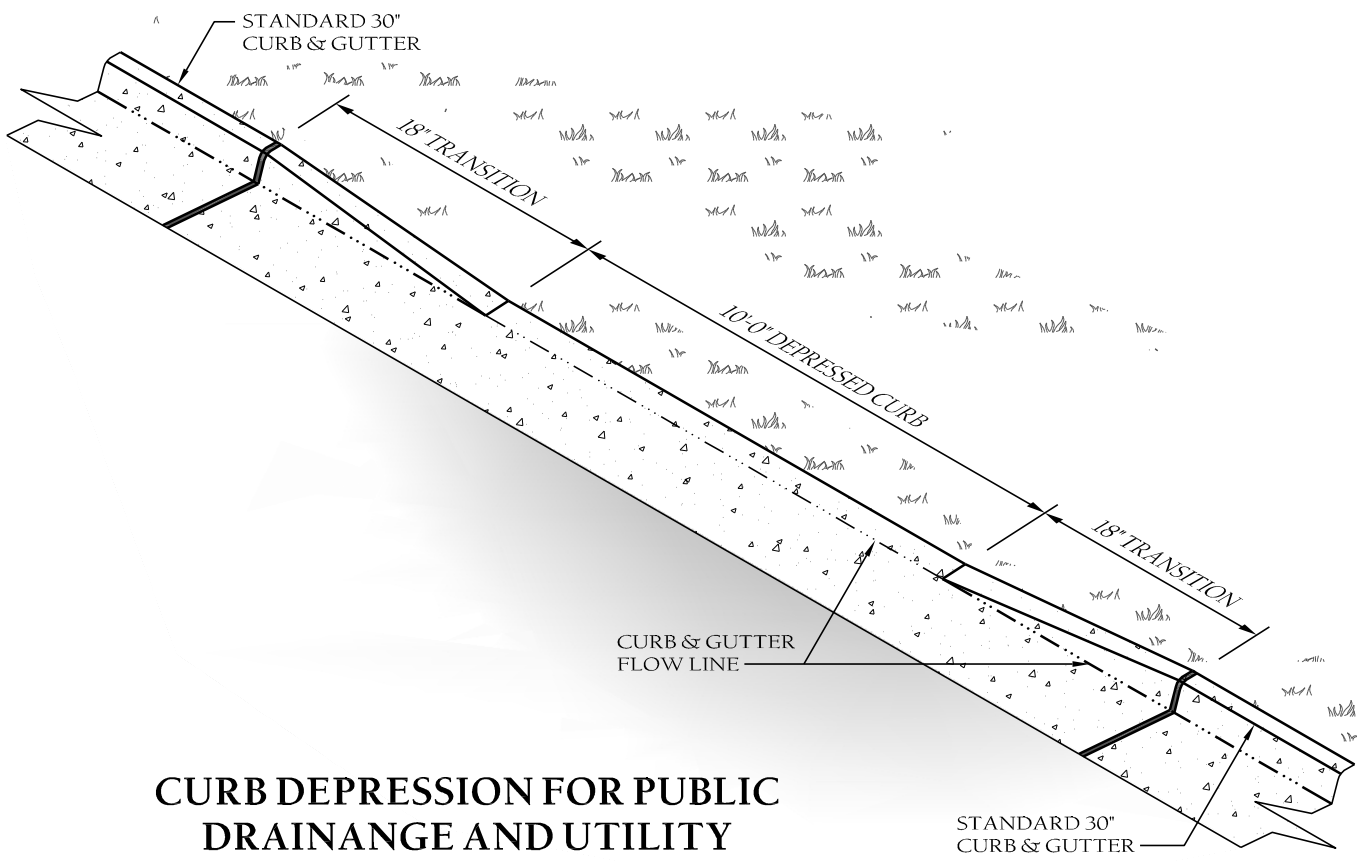

CURB DEPRESSION FOR PUBLIC DRAINAGE AND UTILITY EASEMENT ACCESS



TOWN of WAKE FOREST, NC
Manual of Specifications, Standards and Design

10' CURB DEPRESSION

Scale:
Not To Scale

Revision Date:
Feb., 2015

Detail #:
9.18

Sheet #:
1 of 1

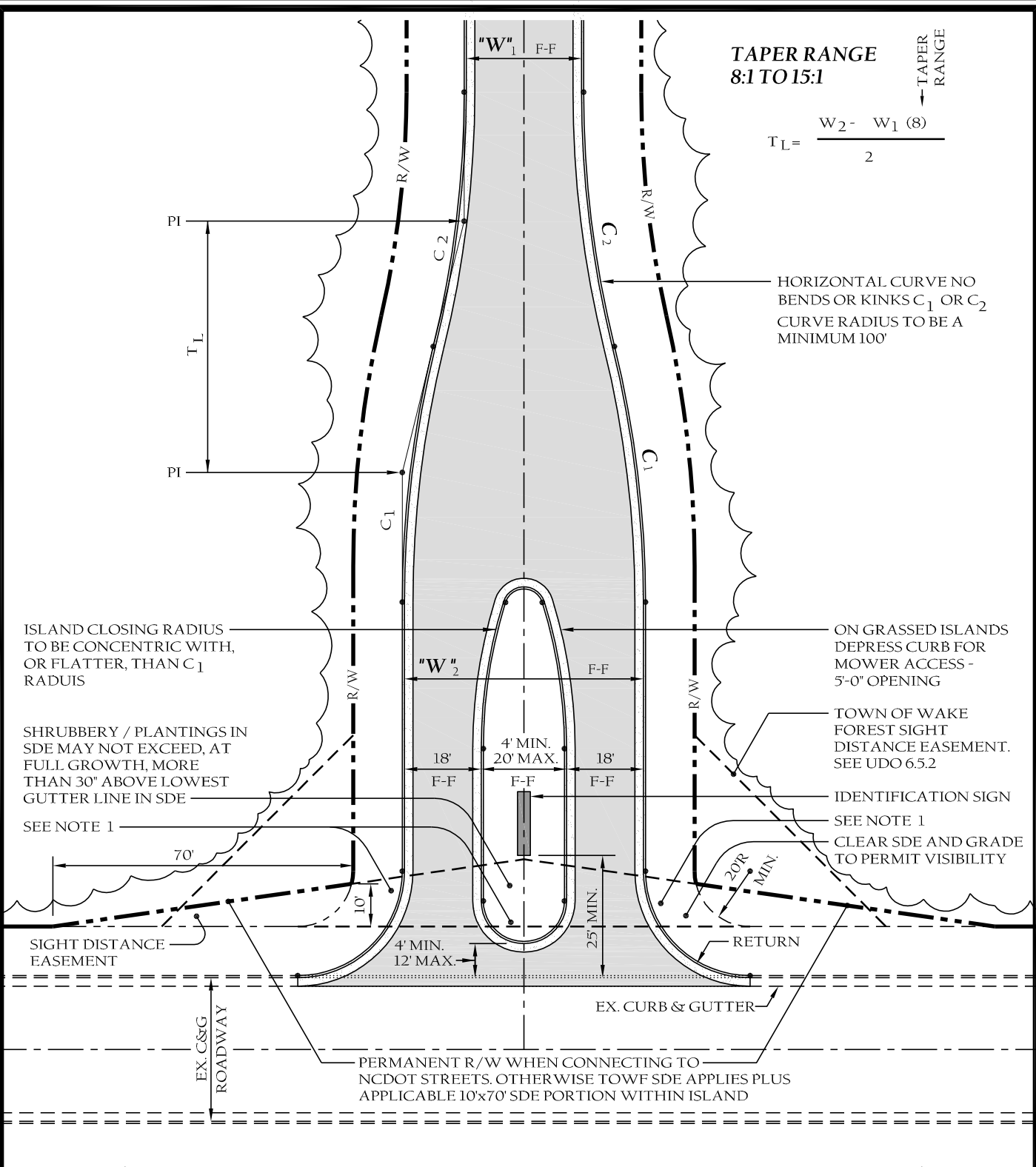

NOTES:

1. Refer to curb ramp details for requirements where sidewalks are required



TOWN of WAKE FOREST, NC
Manual of Specifications, Standards and Design

**ISLAND ENTRANCE TO
EXISTING CURB & GUTTER**

Scale: Not To Scale	Detail #: 9.19
Revision Date: Feb., 2015	Sheet #: 1 of 2

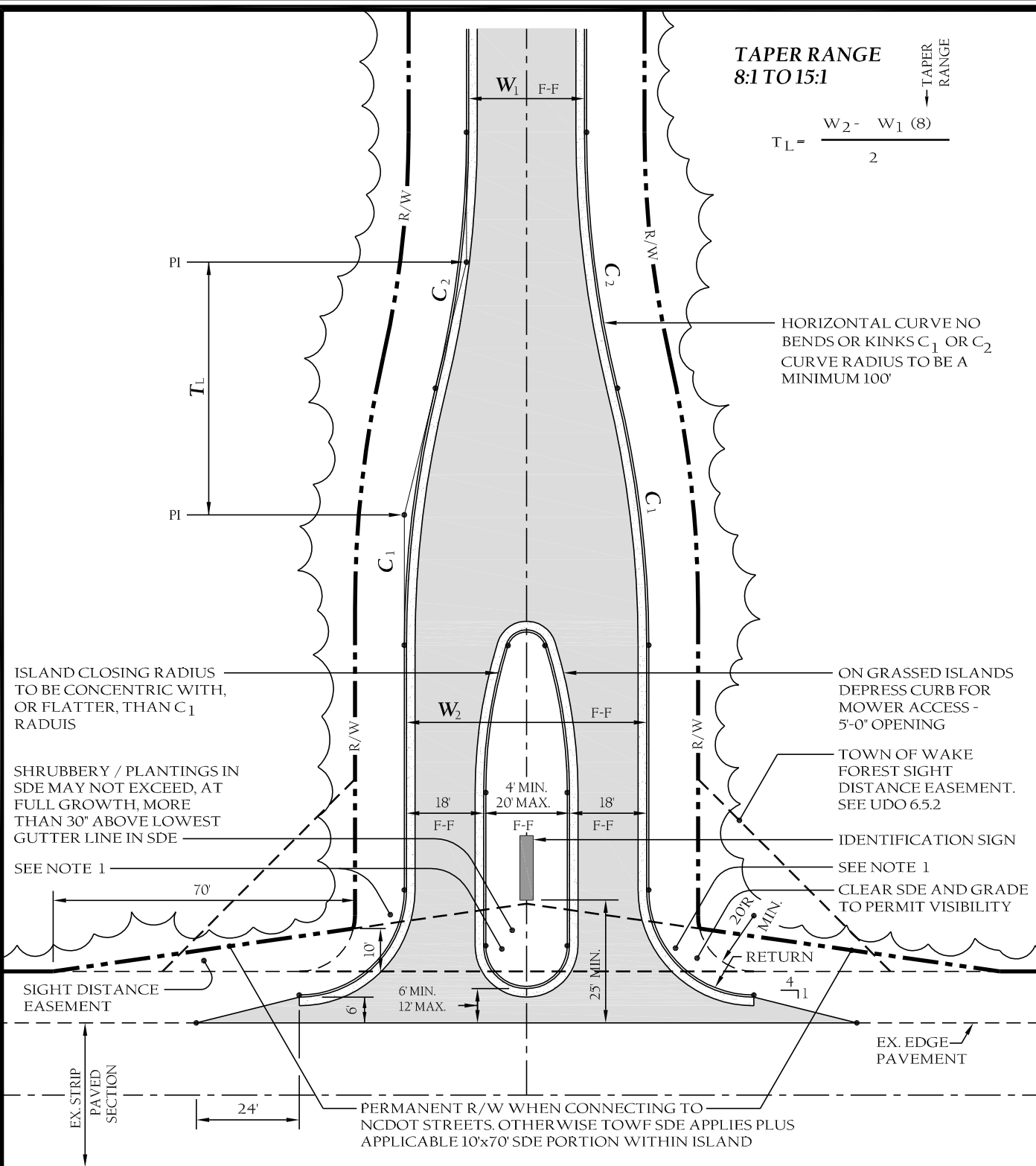

NOTES:

1. Refer to curb ramp details for requirements where sidewalks are required



TOWN of WAKE FOREST, NC
Manual of Specifications, Standards and Design

ISLAND ENTRANCE TO EXISTING STRIP PAVED

Scale: Not To Scale	Detail #: 9.19
Revision Date: Feb., 2015	Sheet #: 2 of 2

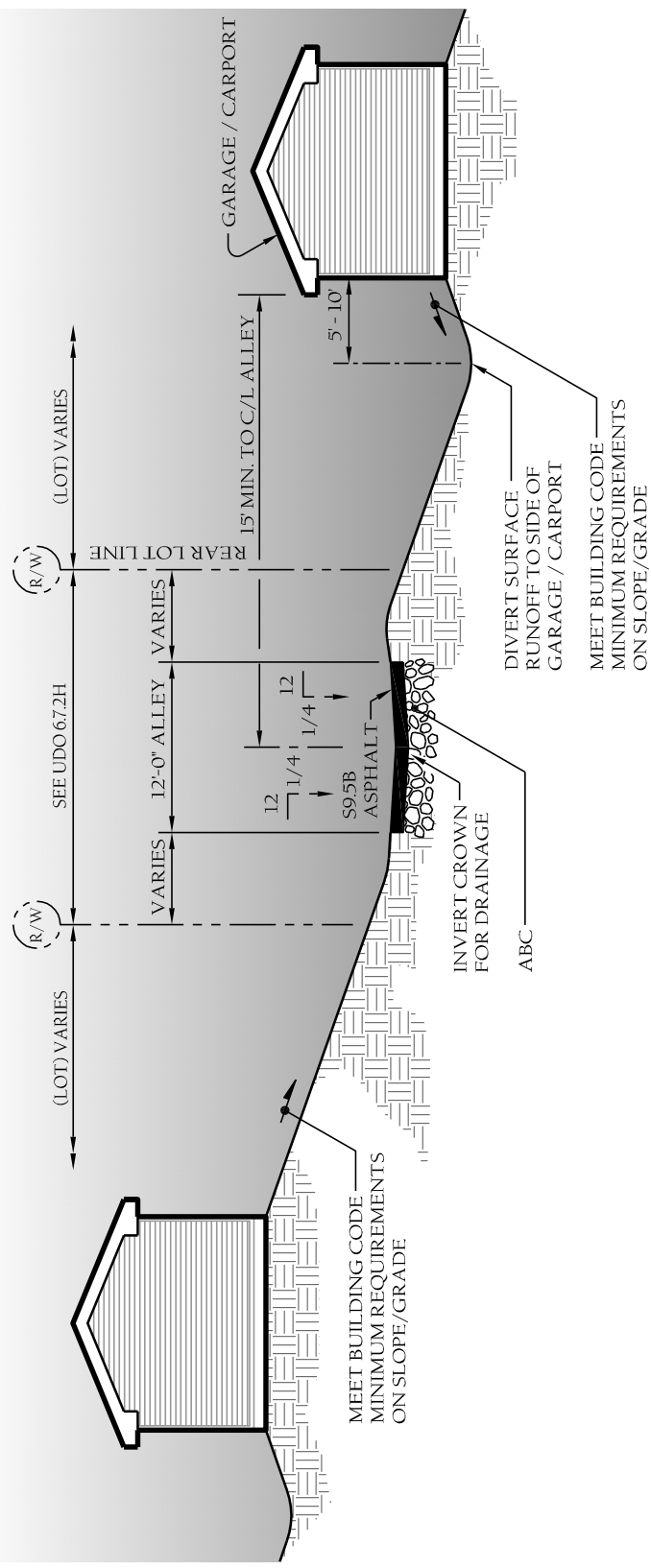

NOTES:

- When so required or proposed by the subdivider, alleys shall conform to the following:
1. Property line radius at intersections.....20 ft.
 2. Minimum radius to centerline when deflection angle of more than 10 degrees occurs.....35 ft..
 3. Pavement radius at intersecting street.....20 ft.
 4. See UDO 6.7.2 for other requirements.



TOWN of WAKE FOREST, NC
Manual of Specifications, Standards and Design

TYPICAL SERVICE ALLEY DETAIL

Scale: Not To Scale	Detail #: 9.20
Revision Date: Feb., 2015	Sheet #: 1 of 1

Note: See UDO 9.4 & 9.5 for other parking requirements.

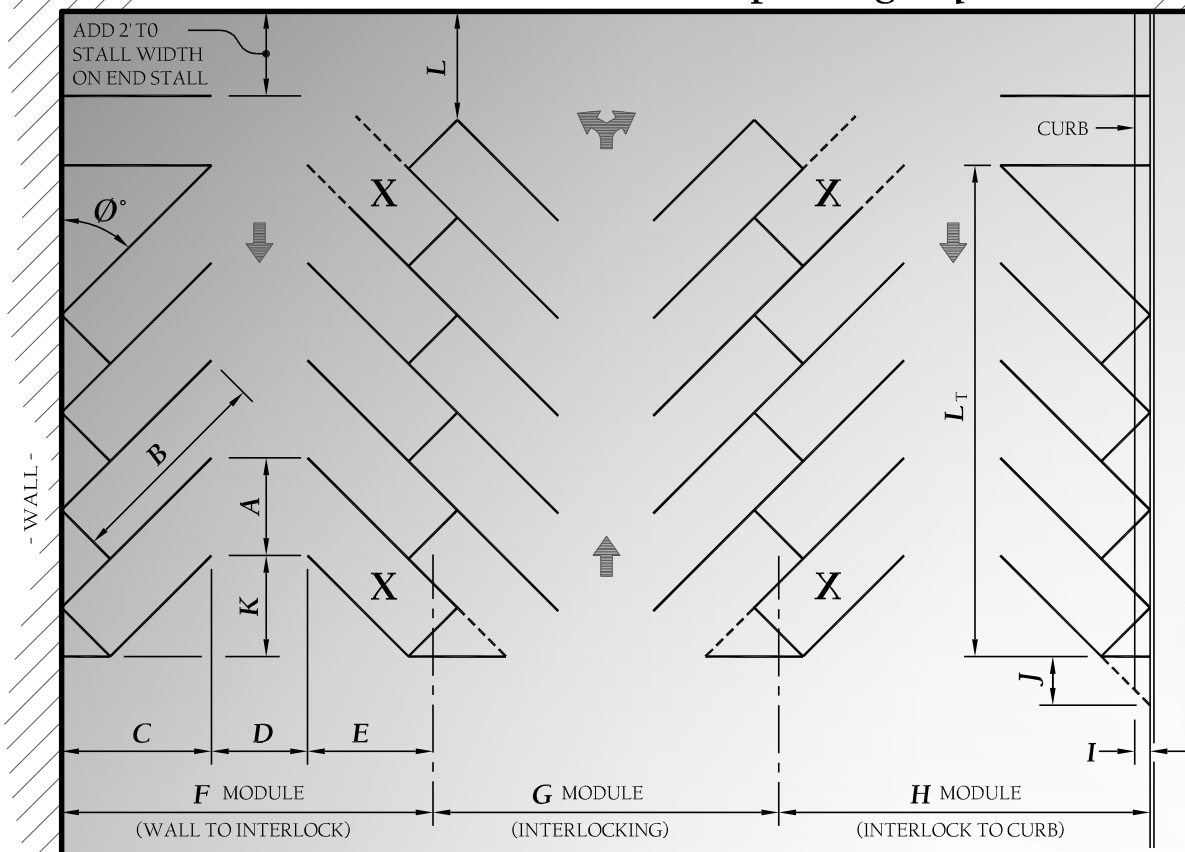

NOTES:

$L_T =$ TOTAL LENGTH AVAILABLE

$\frac{L_T - K}{A} =$ # SPACES PER ROW

X - STALL NOT ACCESSIBLE IN CERTAIN LAYOUTS
90° MUST HAVE 2 WAY ISLES
STALL LAYOUT ELEMENTS. SOURCE:
BASED ON PARKING PRINCIPLES, SPECIAL REPORT
NO. 125, HIGHWAY RESEARCH BOARD, WASHINGTON,
D.C., 1971, P99.

PARKING LAYOUT DIMENSIONS at VARIOUS ANGLES
 (DIMENSION IN FEET)

Dimension	On Diagram	STANDARD CARS (9x18.5 STALLS)				COMPACT CARS (8x16 STALLS)			
		ANGLE θ°				ANGLE θ°			
		45°	60°	75°	90°	45°	60°	75°	90°
Stall width, parallel to aisle	A	12.7	10.4	9.3	9.0	11.3	9.2	8.3	8
Stall length of line	B	27.5	23.7	20.9	18.5	24.0	20.6	18.1	16
Stall depth to wall	C	19.5	20.5	20.0	18.5	17.0	17.9	17.5	16
Aisle width between stall lines	D	12.0	16.0	23.0	26.0	12.0	16.0	20.0	22
Stall depth, interlock	E	16.5	18.5	19.0	18.5	14.2	15.9	16.5	16
Module, wall to interlock	F	48.0	55.0	62.0	63.0	43.2	49.8	54.0	54
Module, interlocking	G	45.0	53.0	61.0	63.0	39.3	47.3	53.0	52
Module, interlock to curb face	H	46.0	52.5	59.5	60.5	40.7	48.0	52.0	50
Bumper overhang (typical)	I	2.0	2.3	2.5	2.5	1.5	1.8	2.0	2
Offset	J	6.4	2.6	0.6	0.0	5.7	2.3	0.6	0
Setback	K	13.1	9.3	4.8	0.0	11.3	8.0	4.1	0
Cross aisle, one-way	L	14.0	14.0	14.0	14.0	13.0	13.0	13.0	13
Cross aisle, two-way	-	24.0	24.0	24.0	24.0	20.0	20.0	20.0	20



TOWN of WAKE FOREST, NC
 Manual of Specifications, Standards and Design

PARKING STALL LAYOUT

Scale: Not To Scale

Detail #: 9.21

Revision Date: Feb., 2015

Sheet #: 1 of 1

STANDARD "STOP" SIGN

WITHOUT CURB OR GUTTER

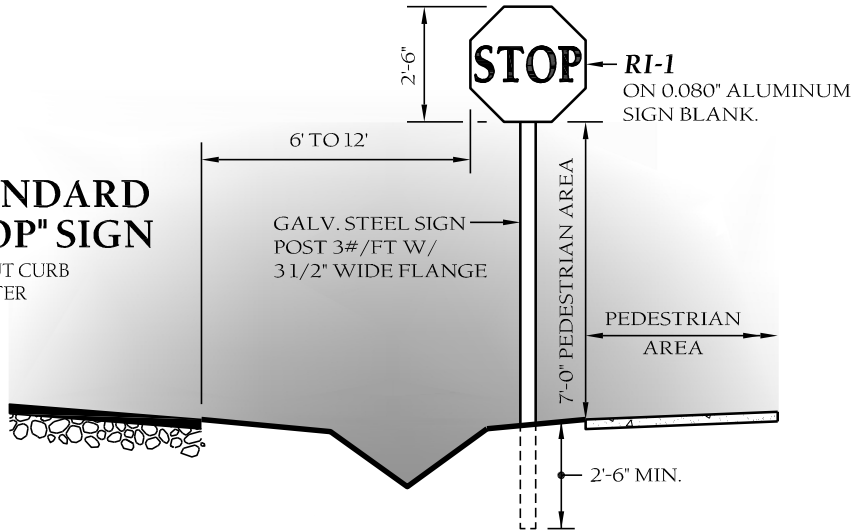

OTHER REGULATORY SIGNS

WITH TYPICAL VALLEY GUTTER

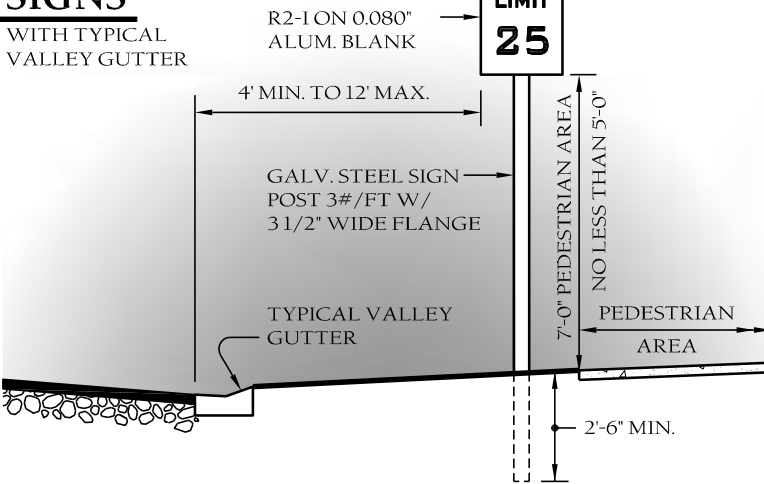

NOTES:

1. Street name signs shall be a minimum of extruded aluminum blades. See sheet 2.
2. All reflective signs shall be made of engineering grade or high intensity grade reflective sheeting or approved equivalent.
3. All signs placed in right-of-way will be approved by town's engineer.
4. Erect street signs plumb.
5. Developer shall be responsible for furnishing & erecting all street name & regulatory signs.

STANDARD STREET NAME SIGN

(SEE NOTES & SHEET 2)
WITH CONCRETE CURB & GUTTER

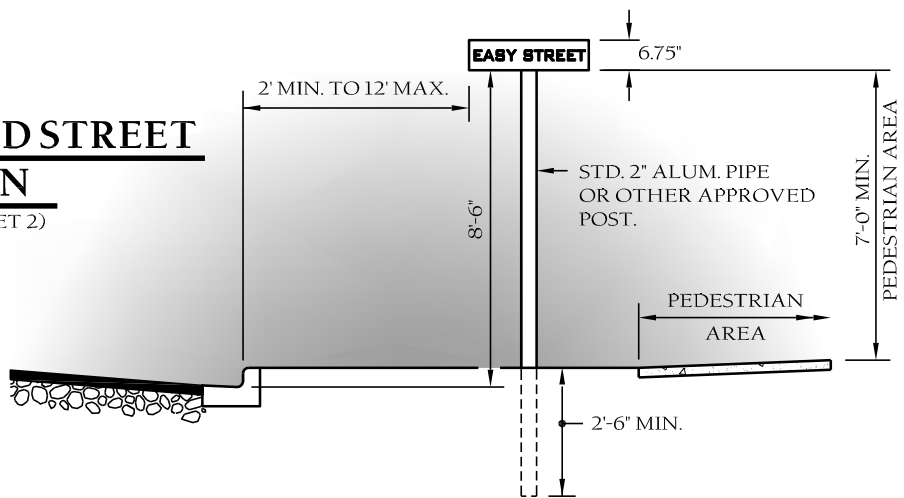

TOWN of WAKE FOREST, NC

Manual of Specifications, Standards and Design

STANDARD SIGN INSTALLATION DETAIL

Scale:
Not To Scale

Detail #:
9.22

Revision Date:
Feb., 2015

Sheet #:
1 of 2

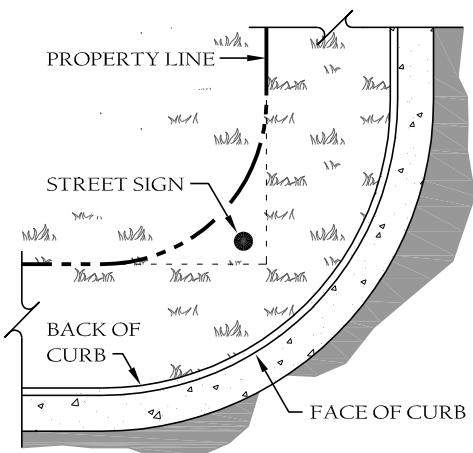

PLAN VIEW

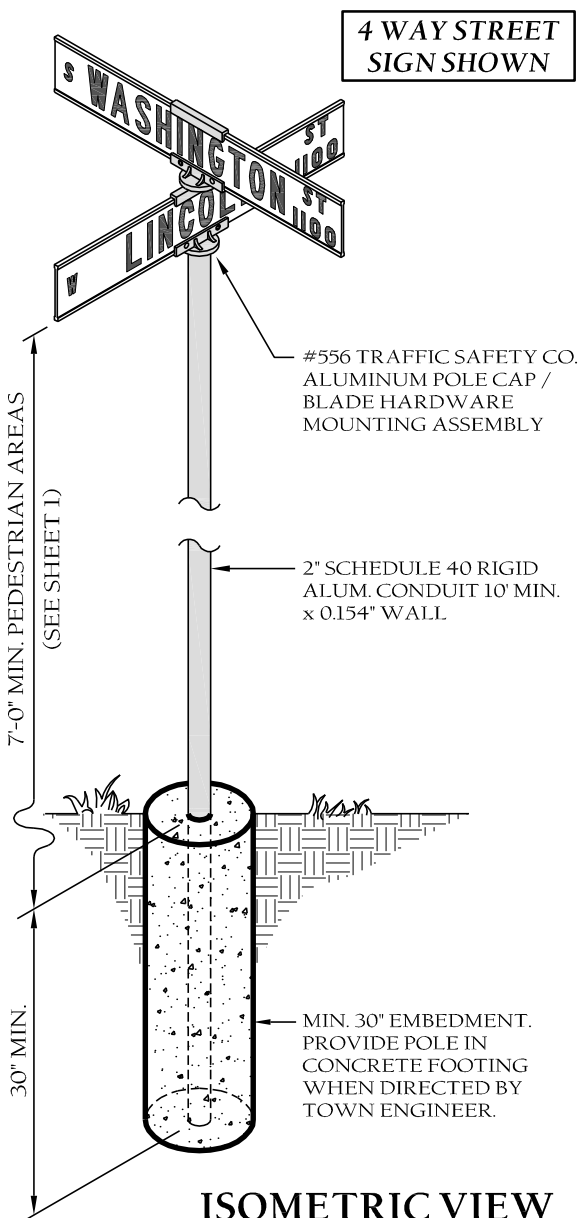

ISOMETRIC VIEW

NOTES:

1. 4" letters to be series "C" (FHWA)
2. 2" letters to be series "C" (FHWA)
All letters and background materials to be "Scotchlite" or an approved equal and meet I.T.E. Specifications on reflectivity.
3. Sign appearance shall be green background with white letters.
4. Fabricate sign as follows: Base sheeting shall be 3-M 3930 Hi-Intensity Prismatic (or equal). Overlay letter mask using 3-M I177-C translucent EC green film. (Note: 3-M DG3 material acceptable alternative)
5. Aluminum sign blank materials to be 0.080" thick with extruded aluminum blades.

RECOMMENDED INSTALLATION

1. Street name sign to be one-foot from property line if said lines were extended.
2. Sign blades not to extend past back of curb into road.
3. Sign location to be placed on low side of the town engineer.
4. Any exceptions to be approved by the Town Engineer.
5. Developer responsible for installation of all street signs.



TOWN of WAKE FOREST, NC
Manual of Specifications, Standards and Design

RESIDENTIAL STREET NAME SIGNS
6 3/4" SIGN HEIGHT

Scale: Not To Scale	Detail #: 9.22
Revision Date: Feb., 2015	Sheet #: 2 of 2



TOWN of
WAKE FOREST

TOWN of WAKE FOREST, NC
Manual of Specifications, Standards and Design

**RESERVED
FUTURE DETAIL**

Scale:
Not To Scale

Detail #:
9.23

Revision Date:
Feb., 2015

Sheet #:
1 of 1



TOWN of
WAKE FOREST

TOWN of WAKE FOREST, NC
Manual of Specifications, Standards and Design

**RESERVED
FUTURE DETAIL**

Scale:
Not To Scale

Detail #:
9.24

Revision Date:
Feb., 2015

Sheet #:
1 of 1

SLIMLINE SHELTER

VERIFY DIMENSIONS WITH MANUFACTURER
(BRASCO MODEL TL 510 C)

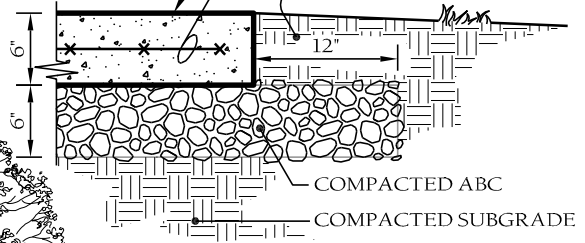
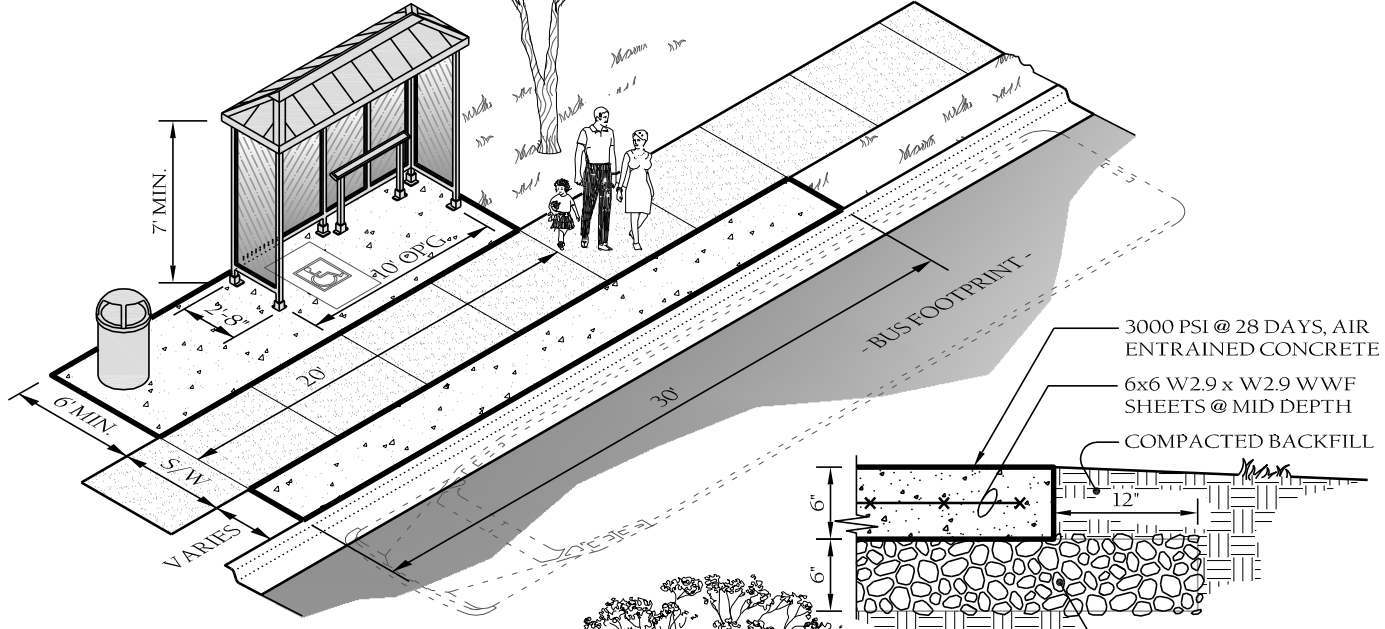

SHELTER PAD SECTION

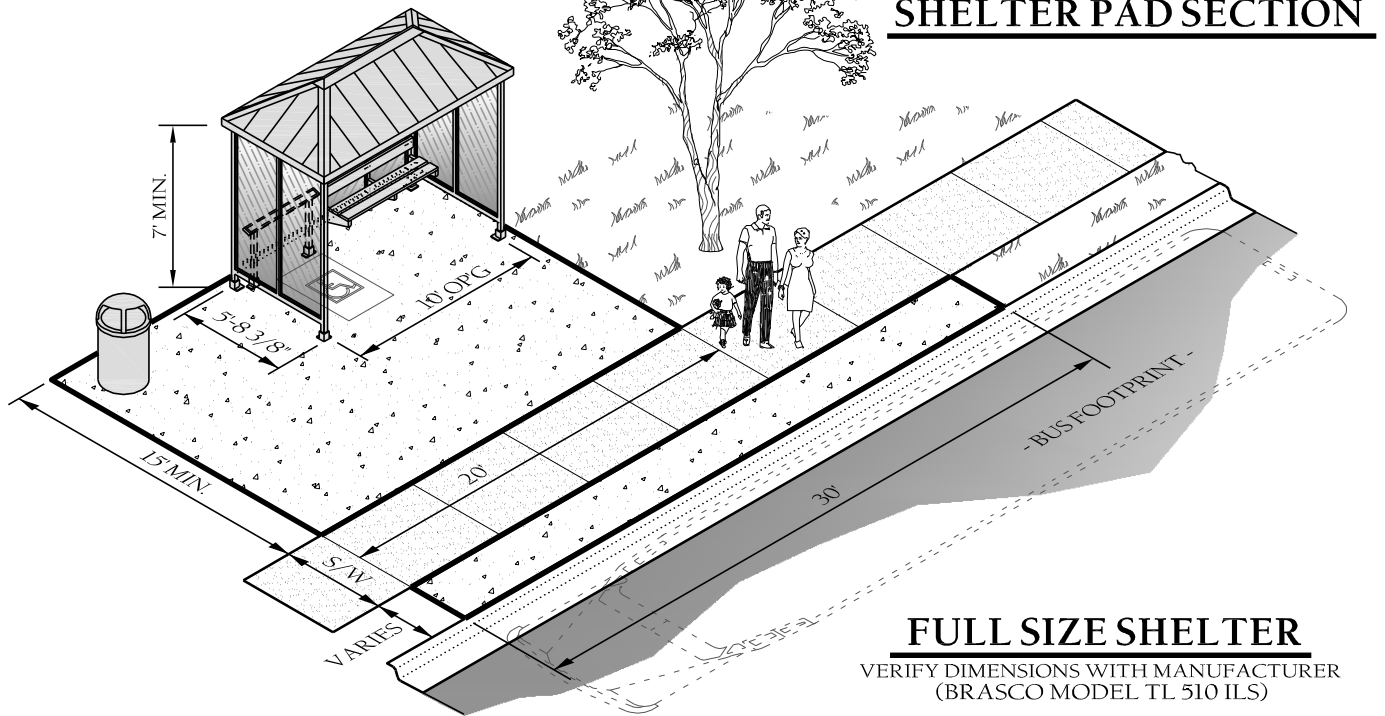

FULL SIZE SHELTER

VERIFY DIMENSIONS WITH MANUFACTURER
(BRASCO MODEL TL 510 ILS)



TOWN of WAKE FOREST, NC

Manual of Specifications, Standards and Design

BUS SHELTER DETAILS

Scale: Not To Scale	Detail #: 9.25
Revision Date: Feb., 2015	Sheet #: 1 of 3

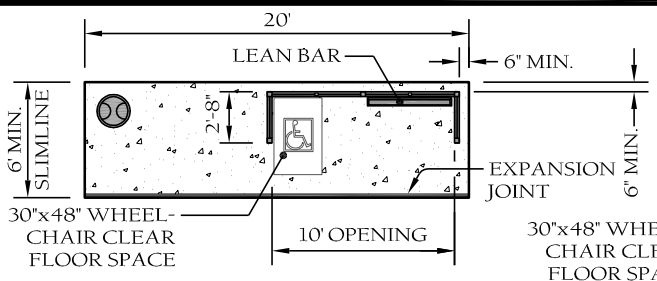

SLIMLINE SHELTER

VERIFY DIMENSIONS WITH MANUFACTURER

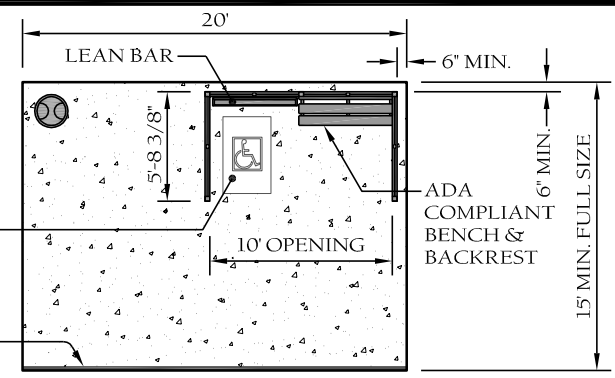

FULL SIZE SHELTER

VERIFY DIMENSIONS WITH MANUFACTURER

TRASH RECEPTACLE. IRONSITES BETHESDA R SERIES MODEL S-42 WITH S-2 RAISED DOME

6" MIN. (SLIMLINE SHELTER)
15" MIN. (FULL SIZE SHELTER)
SEE CONC. PAD SECTION (SHEET 1)

BUS SHELTER (SLIMLINE SHOWN, SEE PLAN VIEWS ABOVE FOR FULL SIZE OPTION)

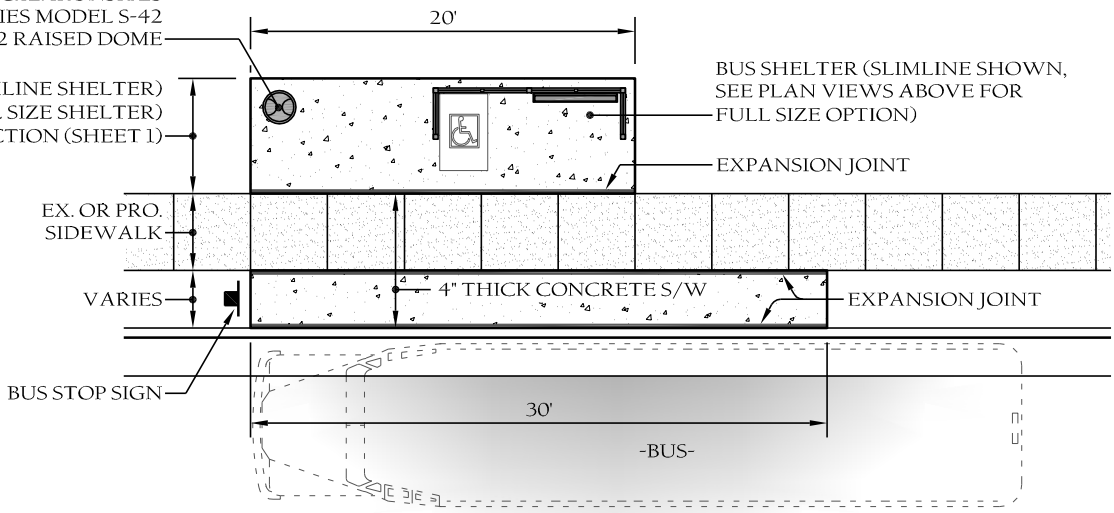

SHELTER LAYOUT WITH EXISTING SIDEWALK

TRASH RECEPTACLE. IRONSITES BETHESDA R SERIES MODEL S-42 WITH S-2 RAISED DOME

6" MIN. (SLIMLINE SHELTER)
15" MIN. (FULL SIZE SHELTER)
SEE CONC. PAD SECTION (SHEET 1)

BUS SHELTER (SLIMLINE SHOWN, SEE PLAN VIEWS ABOVE FOR FULL SIZE OPTION)

NOTES:

1. Install column base(s) 6" from edge of concrete pad, typical unless otherwise specified.
2. Install bench on opposite side of lean bar.
3. If no sidewalk currently exists, provide sidewalk to nearest ADA accessible intersection or driveway with appropriate ramps.
4. Bus stop / shelter pad must be clear of utility poles, fire hydrants & other similar obstacles.
5. See UDO 6.7.2.

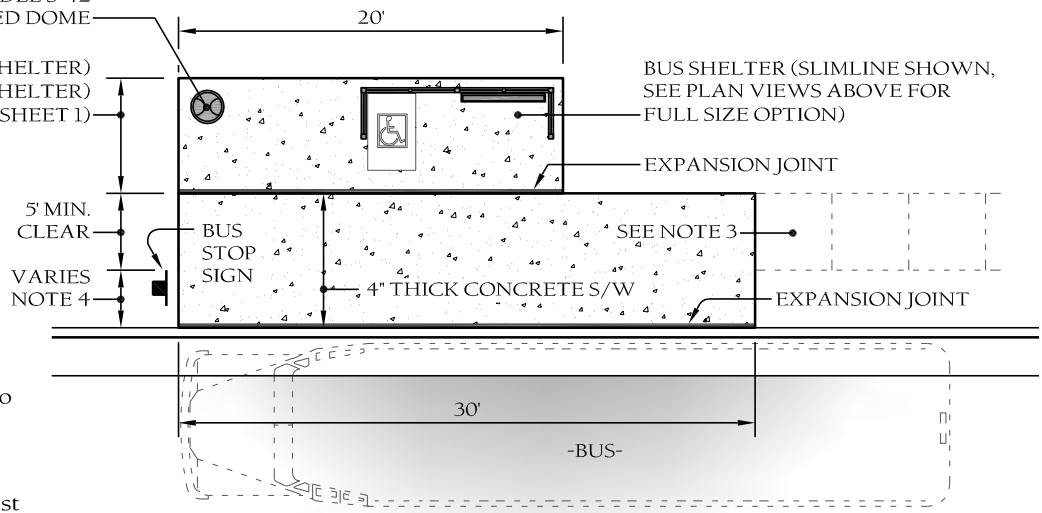

SHELTER LAYOUT WITHOUT EXISTING SIDEWALK



TOWN of WAKE FOREST, NC
Manual of Specifications, Standards and Design

**BUS SHELTER
DETAILS**

Scale: Not To Scale	Detail #: 9.25
Revision Date: Feb., 2015	Sheet #: 2 of 3

FAR SIDE BUS STOPS

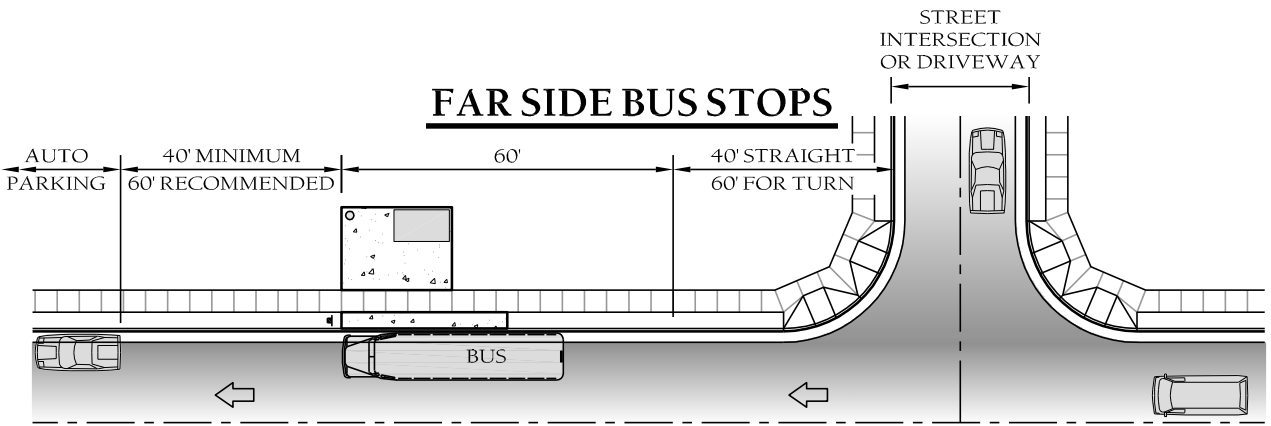

MID BLOCK BUS STOPS

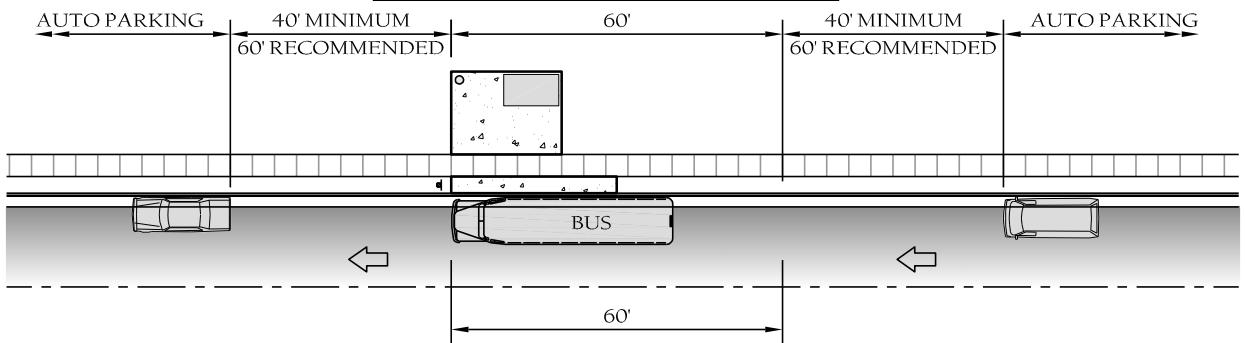

NEAR SIDE BUS STOPS

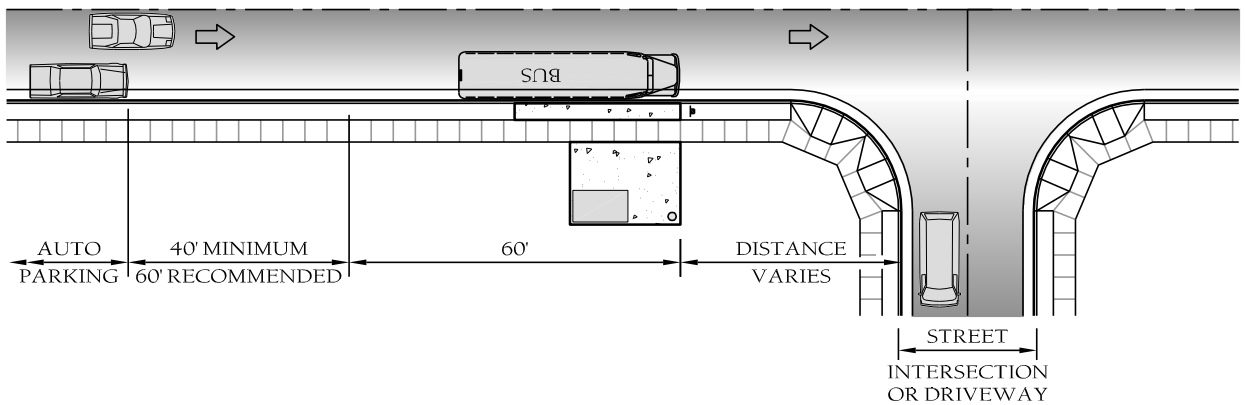

TOWN of WAKE FOREST, NC

Manual of Specifications, Standards and Design

BUS SHELTER DETAILS

Scale:
Not To Scale

Detail #:
9.25

Revision Date:
Feb., 2015

Sheet #:
3 of 3

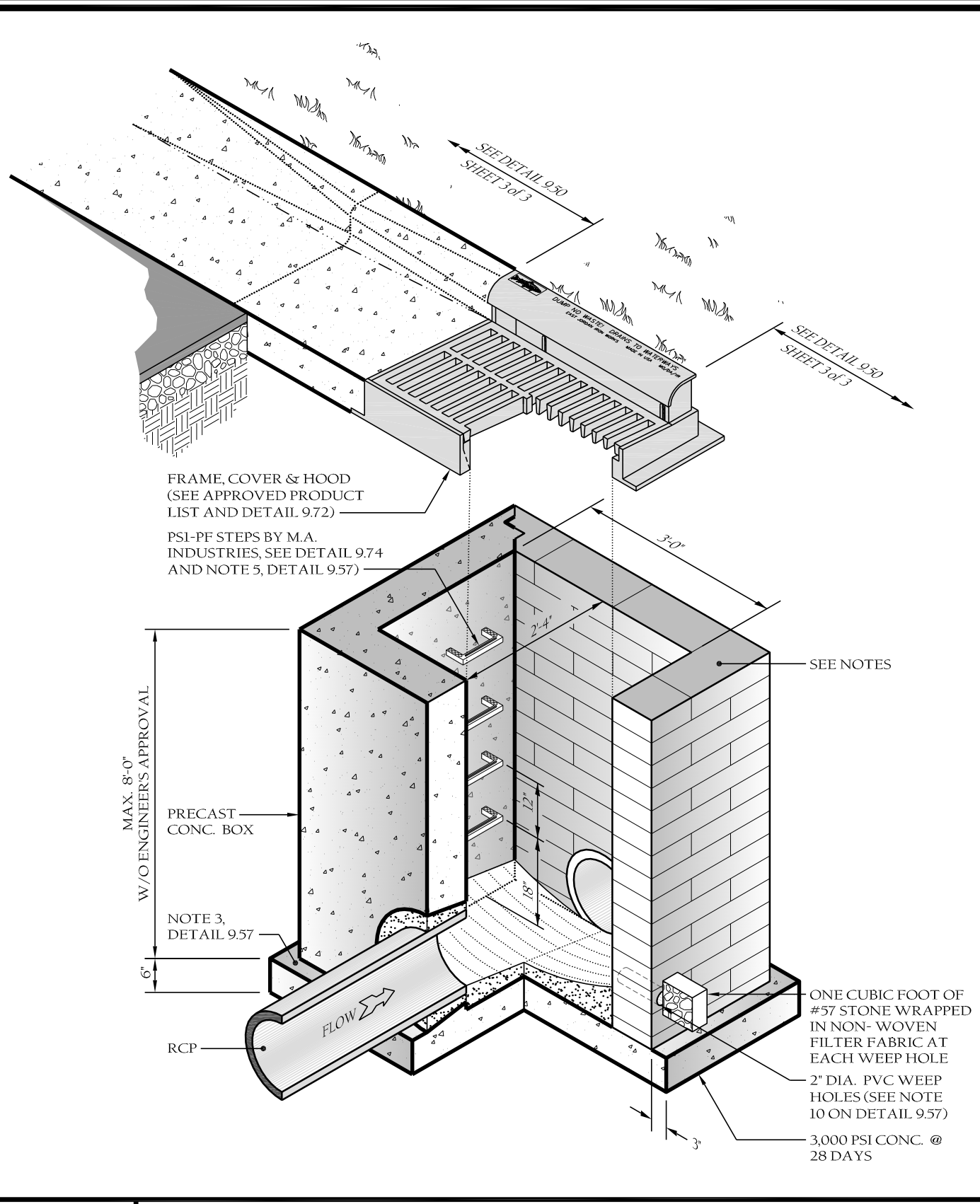

TOWN of WAKE FOREST, NC
Manual of Specifications, Standards and Design

**STD. C&G INLET W/HOOD
DETAIL**

Scale: Not To Scale	Detail #: 9.50
Revision Date: Feb., 2015	Sheet #: 1 of 3

- SEE DETAIL 9.72 AND PRE-APPROVED PRODUCT LIST. (NCDOT DETAIL 840.03 - SHOWN WITH TYPE "E" GRATE) HEAVY DUTY FRAME, COVER & HOOD
- BIKE-FRIENDLY GRATES ARE REQUIRED AT BIKE/PEDESTRIAN CORRIDORS.

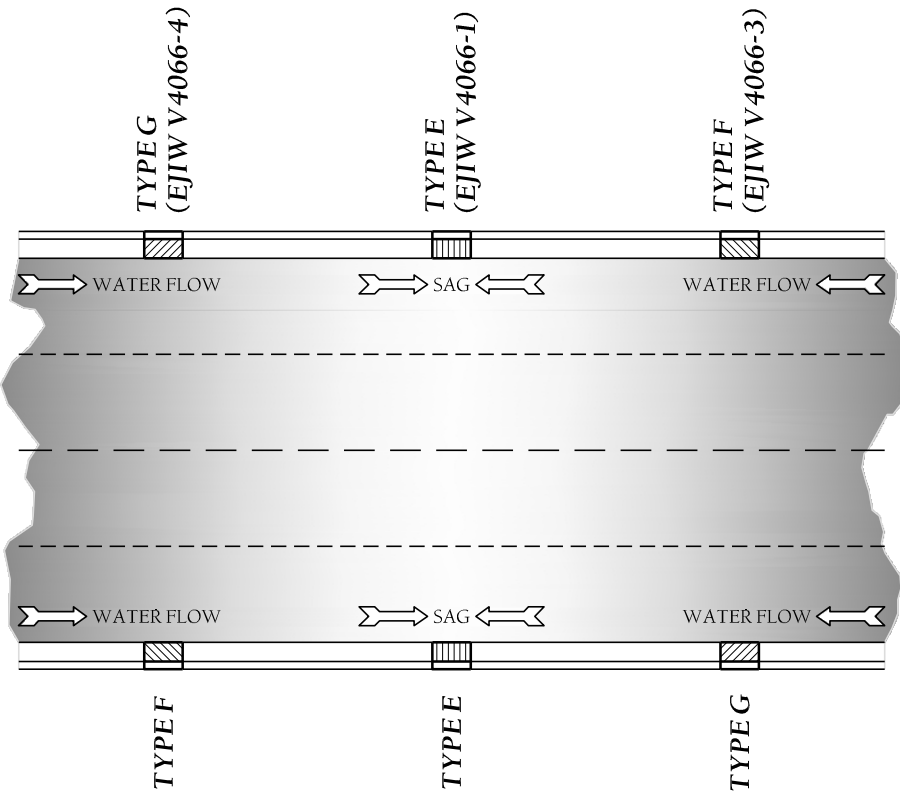
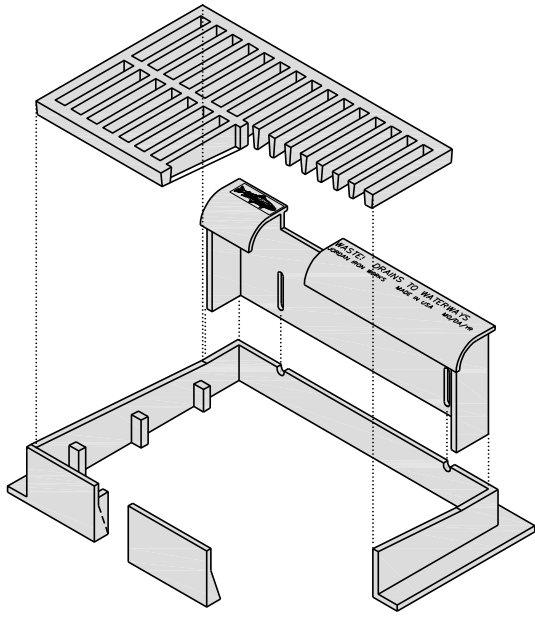

DETAIL SHOWING TYPES OF GRATES TO BE USED ACCORDING TO WATER FLOW



TOWN of WAKE FOREST, NC
Manual of Specifications, Standards and Design

STD. C&G INLET W/HOOD
DETAIL

Scale: Not To Scale	Detail #: 9.50
Revision Date: Feb., 2015	Sheet #: 2 of 3

TRANSITION FROM STD. 30" CURB and GUTTER

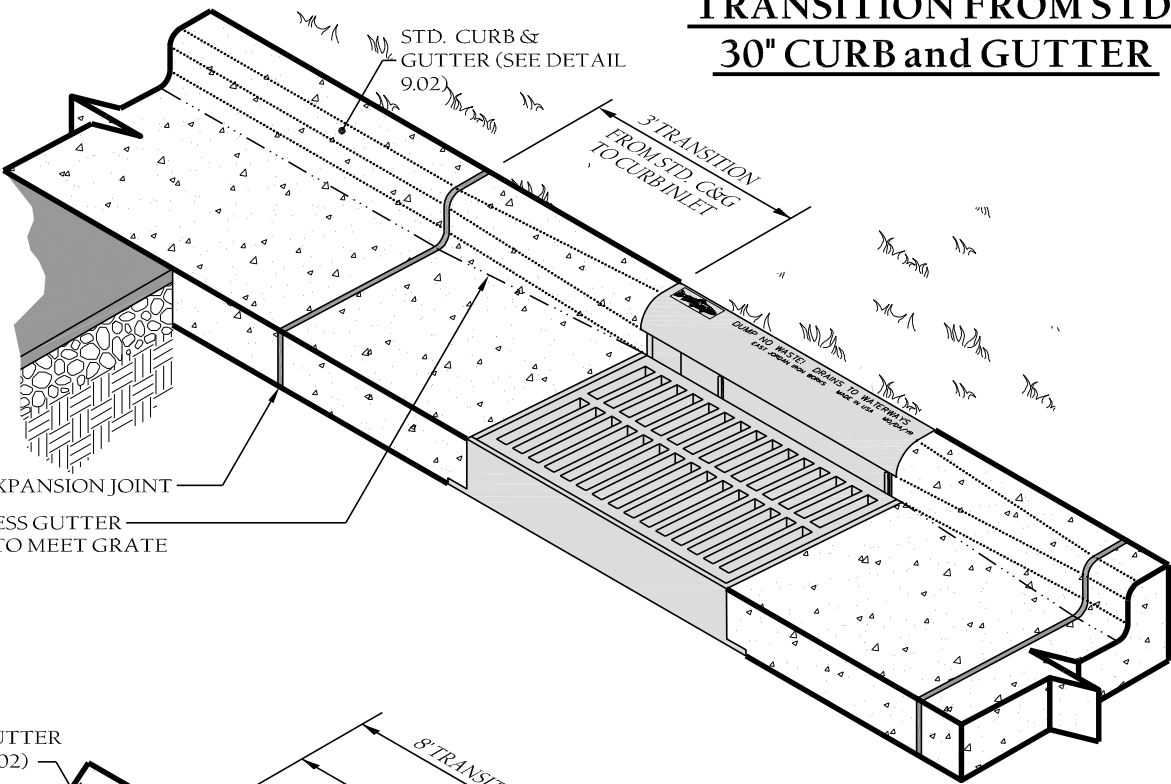

1/2" EXPANSION JOINT
DEPRESS GUTTER
LINE TO MEET GRATE

30" VALLEY GUTTER
(SEE DETAIL 9.02)

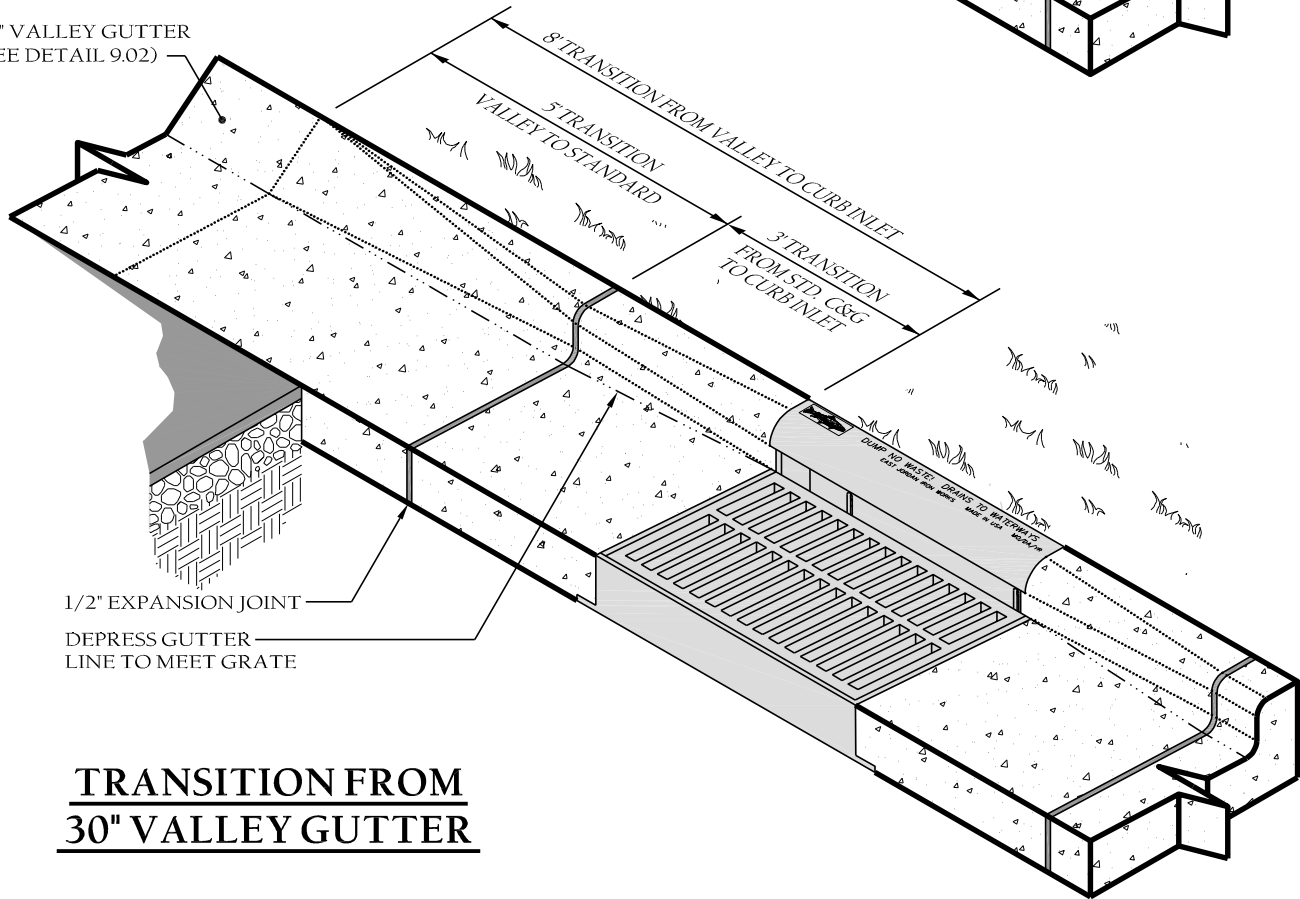

1/2" EXPANSION JOINT
DEPRESS GUTTER
LINE TO MEET GRATE

TRANSITION FROM 30" VALLEY GUTTER

TOWN of WAKE FOREST, NC
Manual of Specifications, Standards and Design

STD. C&G INLET W/HOOD **DETAIL**



Scale:
Not To Scale

Detail #:
9.50

Revision Date:
Feb., 2015

Sheet #:
3 of 3

2x3 DROP INLET
SEE PRE-APPROVED PRODUCTS LIST
AND DETAIL 9.71 FOR GRATE AND
FRAME ASSEMBLY

MORTAR COLLAR

PSI-PF STEPS BY M.A.
INDUSTRIES, SEE DETAIL 9.74
AND NOTE 5, DETAIL 9.57)

ONE CUBIC FOOT OF
#57 STONE WRAPPED
IN NON- WOVEN
FILTER FABRIC AT
EACH WEEP HOLE

2" DIA. PVC WEEP
HOLES (SEE NOTE
10 ON DETAIL 9.57)

SPRINGLINE

FORMED
INVERT

RCP

SEE NOTES

PRECAST
CONC.
BOX

3,000 PSI
CONC. @
28 DAYS

MAX. 8'-0" W/O ENGINEER'S APPROVAL
(SEE NOTES 3&4 ON DETAIL 9.57)

FLOW

3'-10"

4'-10"

6"



TOWN of
WAKE FOREST

TOWN of WAKE FOREST, NC

Manual of Specifications, Standards and Design

STANDARD 2x3 CATCH BASIN

Scale:
Not To Scale

Detail #:
9.51

Revision Date:
Feb., 2015

Sheet #:
1 of 1

END SECTION DIMENSIONS						
DIA.	A	B	C	D	E	X:Y
15"	6"	2'-3"	3'-10"	6'-1"	2'-8"	2.4:1
18"	9"	2'-3"	3'-10"	6'-1"	3'-0"	2.4:1
24"	10"	3'-8"	2'-6"	6'-2"	4'-0"	2.3:1
30"	1'-0"	4'-6"	1'-8"	6'-2"	5'-0"	2.5:1
36"	1'-3"	5'-3"	2'-11"	8'-2"	6'-0"	2.5:1
42"	1'-9"	5'-3"	2'-11"	8'-2"	6'-6"	2.5:1

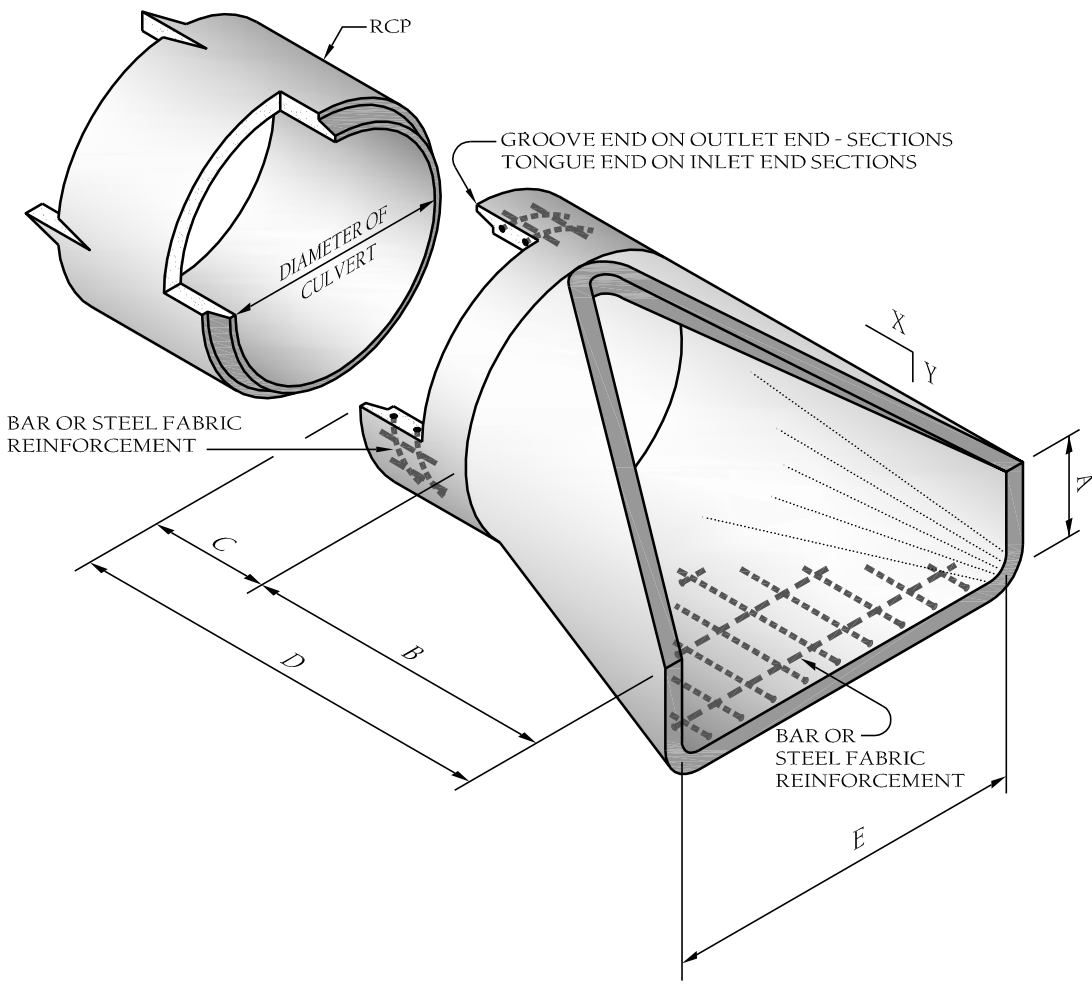

NOTES:

1. Design Of End-section Shall Conform To Standard Reinforced Sectional Concrete Culvert Pipe.
2. Any Twin Barrel System Greater Than 42" Rcp Requires a headwall.
3. Any System Of More Than 2 Pipes Requires a headwall.
4. See NCDOT "Roadway Standard Drawings" for headwall construction details.
5. See Erosion & Sedimentation Manual for dissipation pad design requirements.



TOWN of WAKE FOREST, NC
Manual of Specifications, Standards and Design





STD. FLARED END SECTIONS
DESIGN AID DETAIL

Scale:
Not To Scale

Detail #:
9.52

Revision Date:
Feb., 2015

Sheet #:
1 of 1

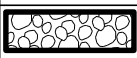
H=	The fill height measured vertically at any point along the pipe from the top of the pipe to the top of the embankment at that point. Do not operate heavy equipment over any pipe culvert until the pipe culvert has been properly backfilled and covered with at least 3 feet of approved material.
	Undisturbed earth material
	Bedding (Middle and Outer): Loosely placed select backfill material meeting NCDOT Class II, Type 1 (washed or unwashed crushed stone screenings) or Class III, Type 1 (NCDOT 2S or 2MS fine aggregate). Leave section directly beneath pipe uncompacted as pipe seating and backfill will accomplish compaction.
	Select Backfill (Below springline): Select backfill material meeting NCDOT Class II, Types 1 or 2 or NCDOT Class III, Types 1 or 2.
	Backfill: Approved suitable local compactable material above springline of pipe meeting Town of Wake Forest specifications.
	Rock Foundation or Unsuitable Material Foundation: Select material NCDOT Class V (#78M stone) or NCDOT Class VI (#57 stone) for foundation conditioning. Encapsulate with engineering fabric as directed by the Engineer; Type 4 soil stabilization fabric (NCDOT Table 1056-1). Overlap all transverse and longitudinal joints in fabric at least 18 inches. Maintain the pipe foundation in a dry condition.

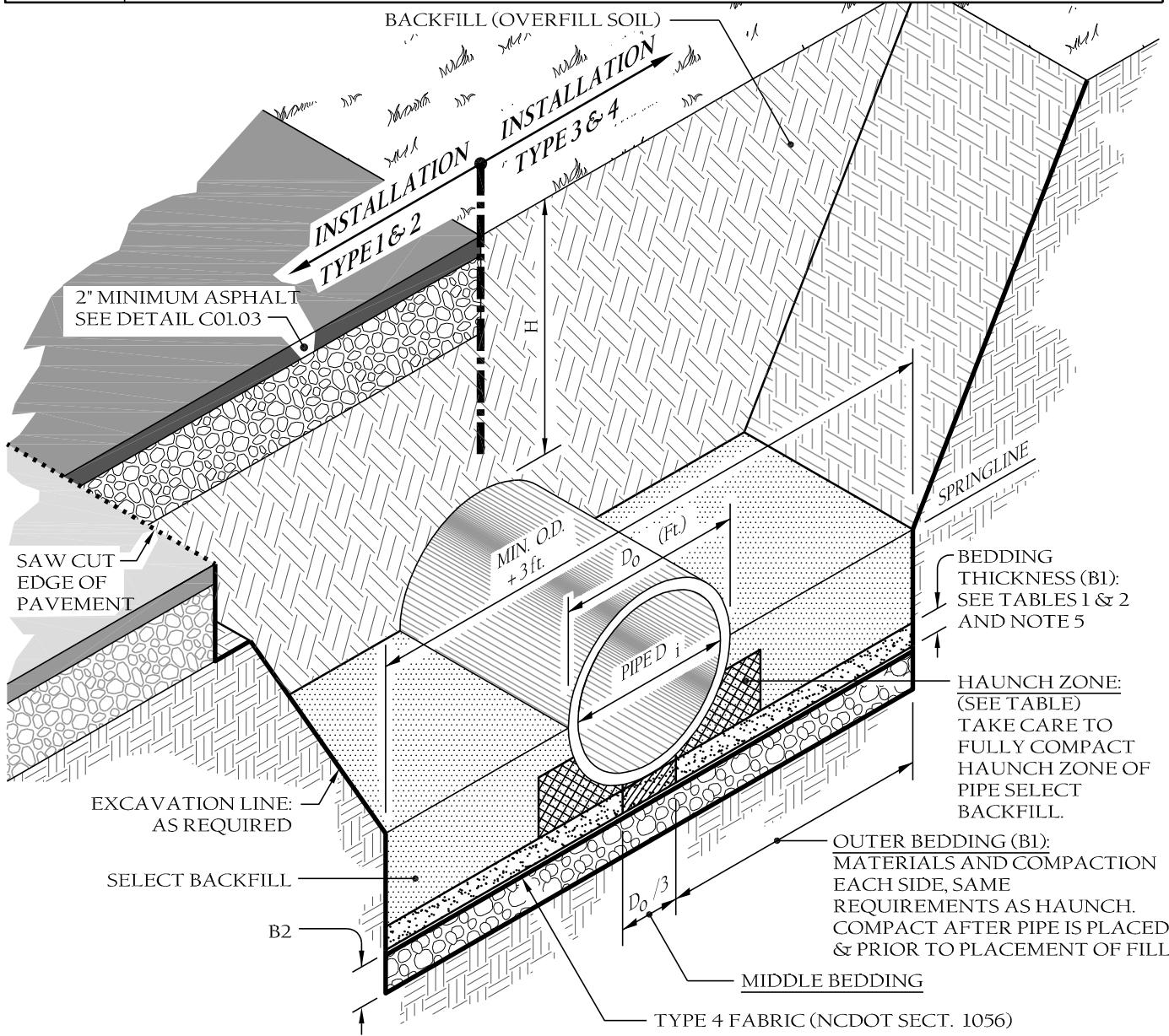

TOWN of WAKE FOREST, NC
Manual of Specifications, Standards and Design

**STORM DRAIN
PIPE INSTALLATION**

Scale: Not To Scale	Detail #: 9.53
Revision Date: Feb., 2015	Sheet #: 1 of 3

Table 1 Equivalent USCS ^a and AASHTO Soil Classifications for SIDD ^b Soil Designations		
SIDD	USCS	NCDOT/AASHTO
Gravelly Sand (Category I)	SW, SP, GW, GP	- NCDOT Class II-Type I (crushed stone screenings), LL < 30; PI ≤ 6. - NCDOT Class III, Type 1 (2S or 2MS), LL < 30; PI ≤ 6.
Sandy Silt (Category II)	GM, SM, Also GC, SC with less than 20% passing #200 sieve	- NCDOT Class II Type 1 (crushed stone screenings) and Class II, Type 2 (AASHTO M145 for A-2-4 with maximum PI of 6, A-4 w/ max 45% passing No. 200 Sieve and a maximum PI of 6) - NCDOT Class III, Type 1 (2S or 2MS) or Class III, Type 2 (AASHTO M145 for soil classification A-1 or A-3)
Silty Clay (Category III)	CL, MH, GC, SC	A5, A6

^a Unified Soil Classification System
^b Standard Installations Direct Design

Table 2 Standard Installations Soils and Minimum Compaction Requirements				
Installation Type	Bedding Thickness	Outer Bedding (B1) Note 5 (% compaction/Category)	Haunch Zone & Select Backfill Area (% compaction/Category)	Location
Type 1	B1 = Di/6 (6" min) B2 = If Rock foundation or over unsuitable foundation, 1/2"/ft of 'H', 12" min/24" max	95% Category I	90% Category I, 95% Category II	Paved Areas with 2' or less bury
Type 2	B1 = Di/6 (6" min) B2 = If Rock foundation or over unsuitable foundation, 1/2"/ft of 'H', 12" min/24" max	90% Category I	85% Category I, 90% Category II	Paved Areas with greater than 2' of bury
Type 3	B1 = Di/6 (6" min) B2 = If Rock foundation or over unsuitable foundation, 1/2"/ft of 'H', 12" min/24" max	85% Category I 90% Category II	85% Category I, 90% Category II, or 95% Category III	In R/W outside of Pavement
Type 4	B1 = Di/6 (6" min) B2 = If Rock foundation or over unsuitable foundation, 1/2"/ft of 'H', 12" min/24" max	No Compaction required, except if Category III, use 85% Category III	No Compaction required, except if Category III, use 85% Category III	Natural Areas

NOTES:

1. Compaction and soil symbols - i.e. "95% Category I" - refers to Category I soil material with minimum standard Proctor compaction of 95%.
2. Soil in the outer bedding, haunch, and lower side zones, except under the middle 1/3 of the pipe, shall be compacted to at least the same compaction as the majority of the soil in the overfill (backfill) zone.
3. For trenches, the top elevation shall be no lower than 0.1H below finished grade or, for roadways, its top shall be no lower than an elevation of 1-foot below the bottom of the pavement base material.
4. For trenches, the width shall be wider than shown if required for adequate space to attain the specified compaction in the haunch and bedding zones.
5. Compact outer bedding after pipe is placed and prior to placement of select fill. Middle bedding is uncompacted.
6. Overfill (Backfill) soils to be placed per standard specification 02700 Storm Drainage for the applicable backfill type and bury limitations.
7. These two tables were excerpted from Design Data 9 and modified to generally conform to the NCDOT Standards as shown in Detail 300.01, Rigid Pipe in Trench Condition.

Reference Sources:

1. ACPA Design Data 9 [April, 2009] (formerly Design Data 40).
2. 2012 NCDOT Standard Specifications for Roads and Structures and NCDOT Standard Details 300.01 for Rigid Pipe, "Trench Condition."



TOWN of WAKE FOREST, NC
 Manual of Specifications, Standards and Design

**STORM DRAIN
 PIPE INSTALLATION**

Scale: Not To Scale	Detail #: 9.53
Revision Date: Feb., 2015	Sheet #: 2 of 3

Fill Height Table ^a				
Inside Pipe Diameter D _i (inches)	Type 3 (Bedding) Installation (0.01 Inch Crack)		Type 4 (Bedding) Installation (0.01 Inch Crack)	
	Class III Pipe Maximum Bury H (feet)	Class IV Pipe Maximum Bury H (feet)	Class III Pipe Maximum Bury H (feet)	Class IV Pipe Maximum Bury H (feet)
15	2 min, 12 max	1 min, 20 max	3 min, 7 max	2 min, 12 max
18	2 min, 12 max	1 min, 20 max	3 min, 7 max	1 min, 13 max
24	1 min, 12 max	1 min, 20 max	2 min, 8 max	1 min, 13 max
30	1 min, 12 max	1 min, 20 max	1 min, 8 max	1 min, 13 max
36	1 min, 12 max	1 min, 20 max	1 min, 8 max	1 min, 13 max
42	1 min, 12 max	1 min, 20 max	1 min, 8 max	1 min, 13 max
48	1 min, 12 max	1 min, 19 max	1 min, 8 max	1 min, 13 max
54	1 min, 12 max	1 min, 19 max	1 min, 8 max	1 min, 13 max
60	1 min, 12 max	1 min, 19 max	1 min, 8 max	1 min, 13 max
72	1 min, 11 max	1 min, 19 max	1 min, 7 max	1 min, 13 max

Fill Height Tables Based On:

1. Y_s= 120 pcf (backfill load)
2. AASHTO HL-93 live load
3. Positive Projecting Embankment Condition (this gives conservative results in comparison to trench conditions).
4. Pipe = Reinforced Concrete Pipe meeting ASTM C76 (AASHTO M170), wall C thickness.
5. Concrete pipe should be installed in accordance with AASHTO LRFD Bridge Construction Specifications, Section 27 or ASTM C1479.

^aFill Height Tables, the portion excerpted here, was developed by the American Concrete Pipe Association (ACPA) using the indirect design method in accordance with Section 12.10.4.3 of the AASHTO LRFD Bridge Design Specification, 4th Edition, 2007 with 2008 Interim.

NOTES:

1. Greater bury depths than those shown above are achievable by either using Type 1 or 2 Installation, using Class V pipe, controlling backfill type, calculating depth using a trench condition, or by Special Design. See also Design Data 9 published by the ACPA for design methodology.
2. In lieu of calculating bury depth for other conditions, first see "LRFD Fill Height Tables for Concrete Pipe", last revised July 2009 (or later), prepared by the ACPA for other bury depth possibilities.



TOWN of WAKE FOREST, NC
Manual of Specifications, Standards and Design

**STORM DRAIN
PIPE INSTALLATION**

Scale:
Not To Scale

Detail #:
9.53

Revision Date:
Feb., 2015

Sheet #:
3 of 3

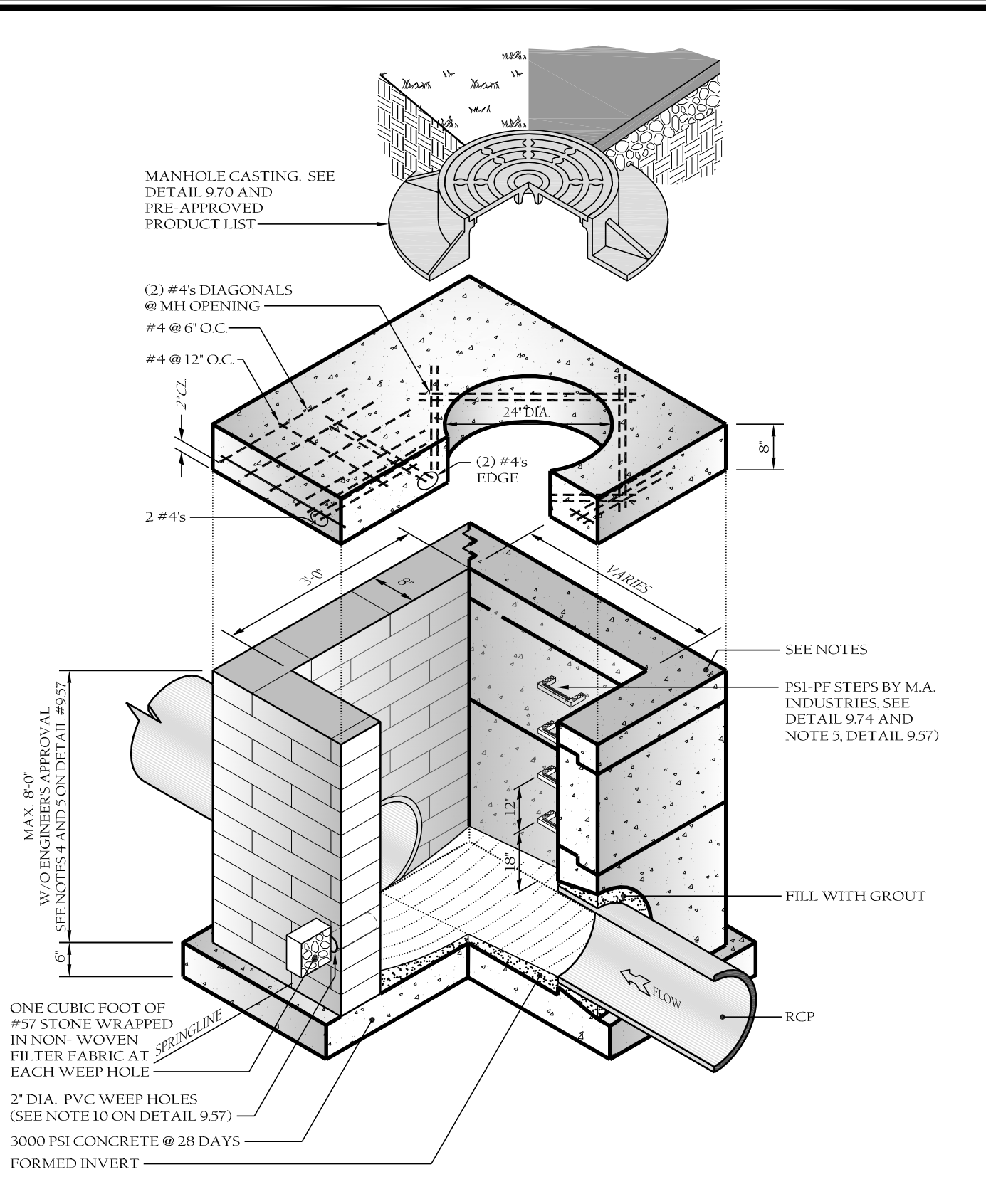

TOWN of WAKE FOREST, NC
Manual of Specifications, Standards and Design

STD. M.H. J.B.
VARIABLE LENGTH

Scale: Not To Scale	Detail #: 9.54
Revision Date: Feb., 2015	Sheet #: 1 of 1

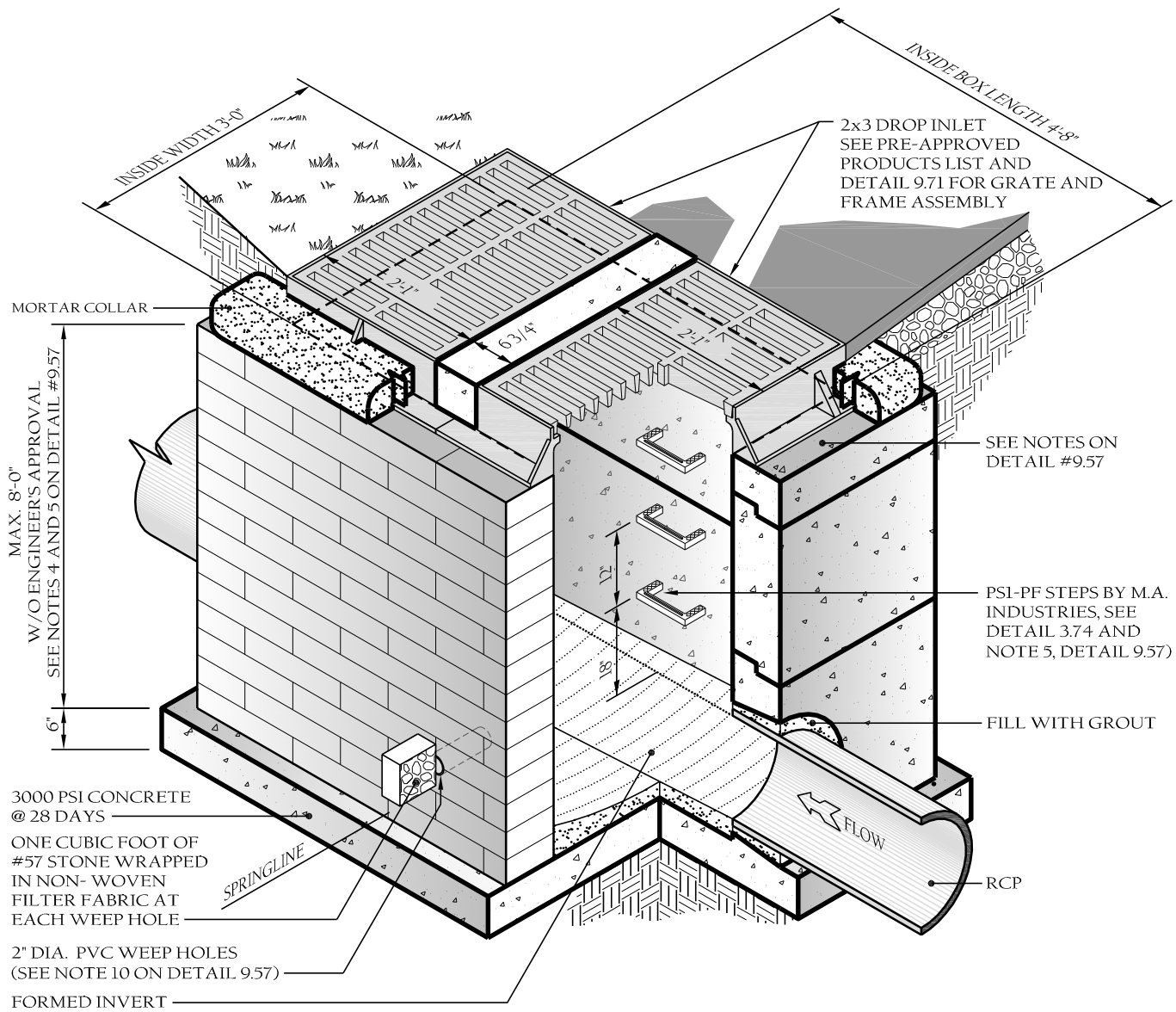

TOWN of WAKE FOREST, NC
Manual of Specifications, Standards and Design

STD. MULTIPLE 2' x 3' CATCH BASIN DETAIL

Scale: Not To Scale	Detail #: 9.55
Revision Date: Feb., 2015	Sheet #: 1 of 1

2x3 DROP INLET
SEE PRE-APPROVED PRODUCTS LIST
AND DETAIL 9.71 FOR GRATE AND
FRAME ASSEMBLY

MORTAR COLLAR

#5 @ 6" O.C.

#5 @ 12" O.C.

2 #5s EDGE

3000 PSI CONCRETE
@ 28 DAYS

ONE CUBIC FOOT OF
#57 STONE WRAPPED
IN NON- WOVEN
FILTER FABRIC AT
EACH WEEP HOLE

2" DIA. PVC WEEP HOLES
(SEE NOTE 10 ON DETAIL 9.57)

FORMED INVERT

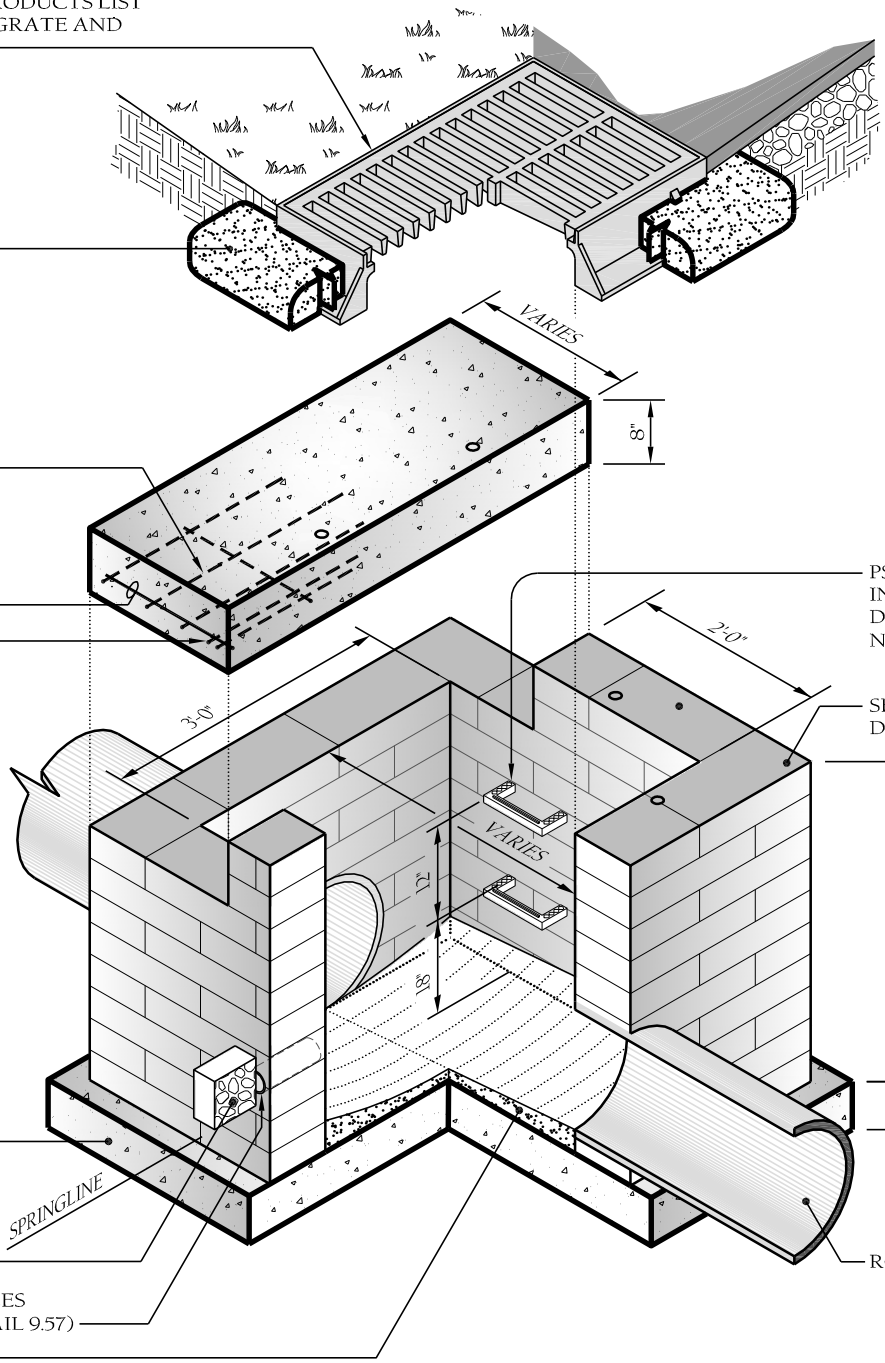

PSI-PF STEPS BY M.A.
INDUSTRIES, SEE
DETAIL 9.74 AND
NOTE 5, DETAIL 9.57)

SEE NOTES ON
DETAIL #9.57

MAX. 8'-0"
W/O ENGINEER'S APPROVAL
SEE NOTES 4 AND 5
ON DETAIL #9.57

6"

RCP



TOWN of WAKE FOREST, NC
Manual of Specifications, Standards and Design

**STD. 3' x VARIABLE LENGTH
BRICK BOX WITH 2' x 3' CATCH BASIN**

Scale:
Not To Scale

Detail #:
9.56

Revision Date:
Feb., 2015

Sheet #:
1 of 2

2x3 DROP INLET
SEE PRE-APPROVED PRODUCTS LIST
AND DETAIL 9.71 FOR GRATE AND
FRAME ASSEMBLY

MORTAR COLLAR

NOTE II

PRECAST BOX

3000 PSI CONCRETE
@ 28 DAYS

ONE CUBIC FOOT OF
#57 STONE WRAPPED
IN NON- WOVEN
FILTER FABRIC AT
EACH WEEP HOLE

2" DIA. PVC WEEP HOLES
(SEE NOTE 10 ON DETAIL 9.57)

FORMED INVERT

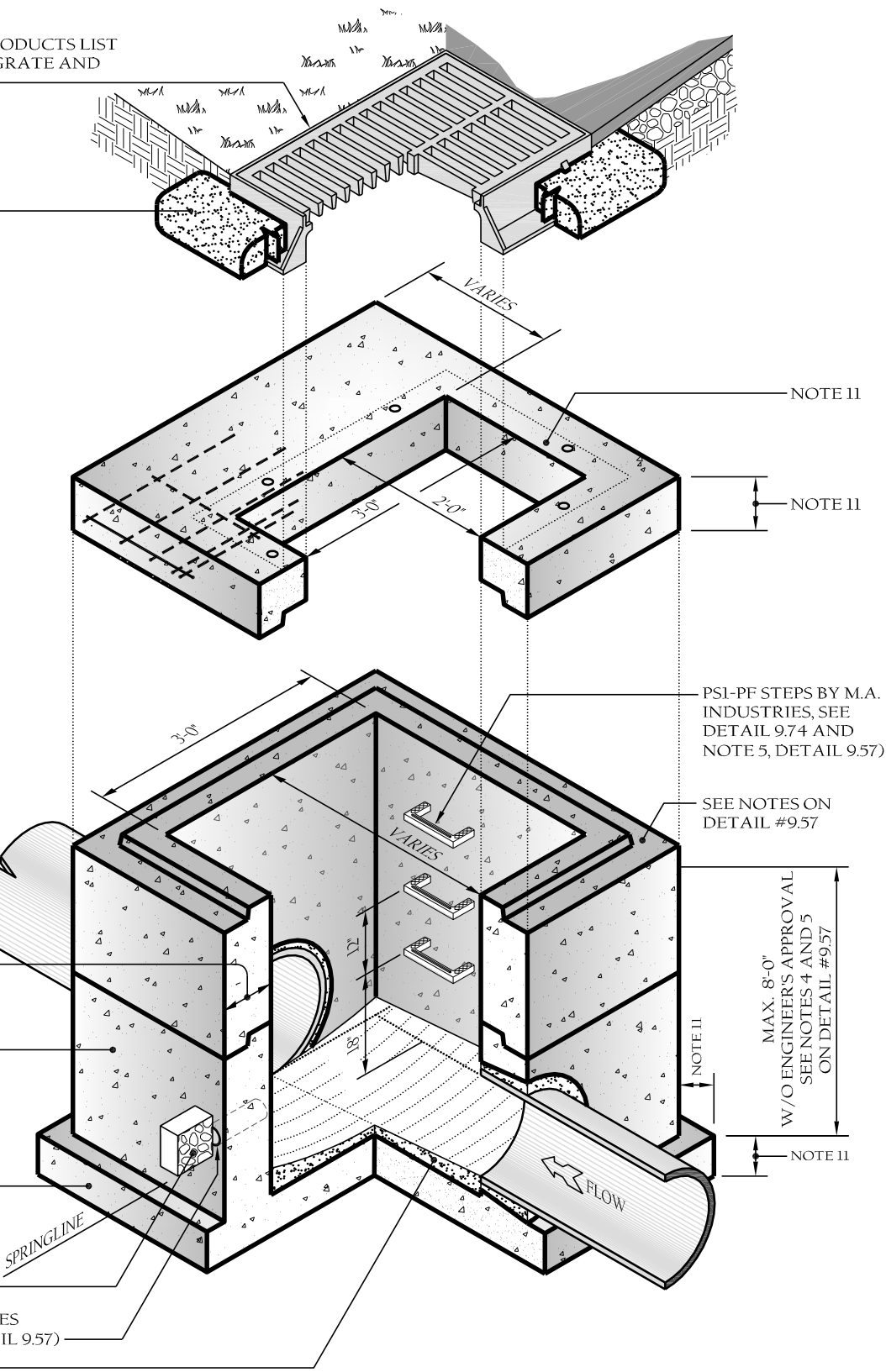

NOTE II

NOTE II

PSI-PF STEPS BY M.A.
INDUSTRIES, SEE
DETAIL 9.74 AND
NOTE 5, DETAIL 9.57)

SEE NOTES ON
DETAIL #9.57

MAX. 8'-0"
W/O ENGINEER'S APPROVAL
SEE NOTES 4 AND 5
ON DETAIL #9.57

NOTE II

NOTE II



TOWN of WAKE FOREST, NC
Manual of Specifications, Standards and Design

**STD. 3' x VARIABLE LENGTH
PRECAST BOX WITH 2' x 3' CATCH BASIN**

Scale: Not To Scale	Detail #: 9.56
Revision Date: Feb., 2015	Sheet #: 2 of 2

Notes:

Drainage Structures Notes.

1. Boxes may be reinforced masonry, masonry, precast concrete or cast-in-place reinforced concrete.
2. Any non-standard box (non-standard meaning not shown in this manual), is to be designed by a NC Professional Engineer.
3. The maximum height of an unreinforced masonry drainage structure with 8" walls shall be limited to 8'-0" from invert of the outlet pipe to the top of the iron casting. Depths greater than 8'-0" shall have walls 12" thick. Basins over 12' in total depth shall be designed by a NC Professional Engineer. Four inch walls are not allowed on drainage structures. Bottom slab on structures shall be reinforced when box depth exceeds 8ft. The maximum horizontal span of an unreinforced brick/block box at 8' deep without engineering, = 5'-0" clear ($K_0=0.66$, $EFP=65$ psf silty/clayey sand).
4. Steps are to be provided on all basins deeper than 42".
5. Steps are to be PSI-PF as manufactured by M. A. Industries or an approved equal. Locate on non-pipe walls. See detail 9.74.
6. Mortar in masonry boxes is to be type M.
7. Clay brick structures are not allowed.
8. Concrete pipe is to be minimum class III.
9. Concrete building brick is to meet ASTM C-90 for Type II. Solid concrete block to be used in lieu of clay brick for minor drainage structure and manholes to meet ASTM C139.
10. Basin located in wet areas, or as otherwise required by the town engineer, shall have weep holes as shown on details.
11. All cast-in-place or precast concrete drainage structures located in paved areas accessible to truck loadings to be designed to meet AASHTO HS 20-44 loading. See manufacturers details for wall, top and bottom thickness.
12. Place minimum 6" #57 stone bedding beneath precast structures.



TOWN of WAKE FOREST, NC
 Manual of Specifications, Standards and Design

DRAINAGE STRUCTURE
NOTES

Scale:
 Not To Scale

Detail #:
9.57

Revision Date:
 Feb., 2015

Sheet #:
 1 of 1



TOWN of
WAKE FOREST

TOWN of WAKE FOREST, NC
Manual of Specifications, Standards and Design

RESERVED
FUTURE DETAIL

Scale:
Not To Scale

Detail #:
9.58

Revision Date:
Feb., 2015

Sheet #:
1 of 1



TOWN of
WAKE FOREST

TOWN of WAKE FOREST, NC
Manual of Specifications, Standards and Design

RESERVED
FUTURE DETAIL

Scale:
Not To Scale

Detail #:
9.59

Revision Date:
Feb., 2015

Sheet #:
1 of 1

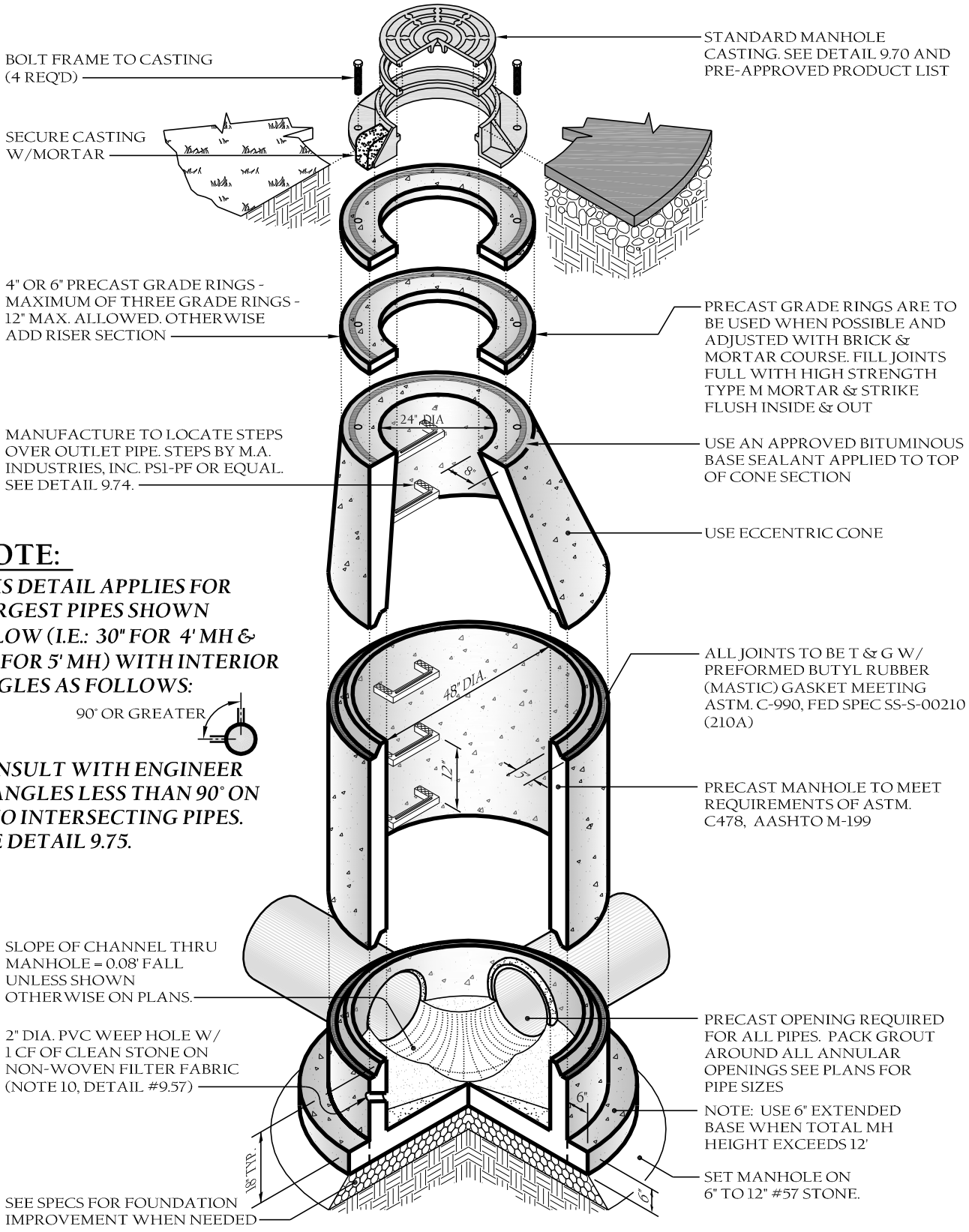

NOTE:

THIS DETAIL APPLIES FOR LARGEST PIPES SHOWN BELOW (I.E.: 30" FOR 4' MH & 42" FOR 5' MH) WITH INTERIOR ANGLES AS FOLLOWS:



CONSULT WITH ENGINEER IF ANGLES LESS THAN 90° ON TWO INTERSECTING PIPES. SEE DETAIL 9.75.



TOWN of WAKE FOREST, NC
Manual of Specifications, Standards and Design

PRECAST CONCRETE
4' DIA. MH JB

Scale: Not To Scale	Detail #: 9.60
Revision Date: Feb., 2015	Sheet #: 1 of 1

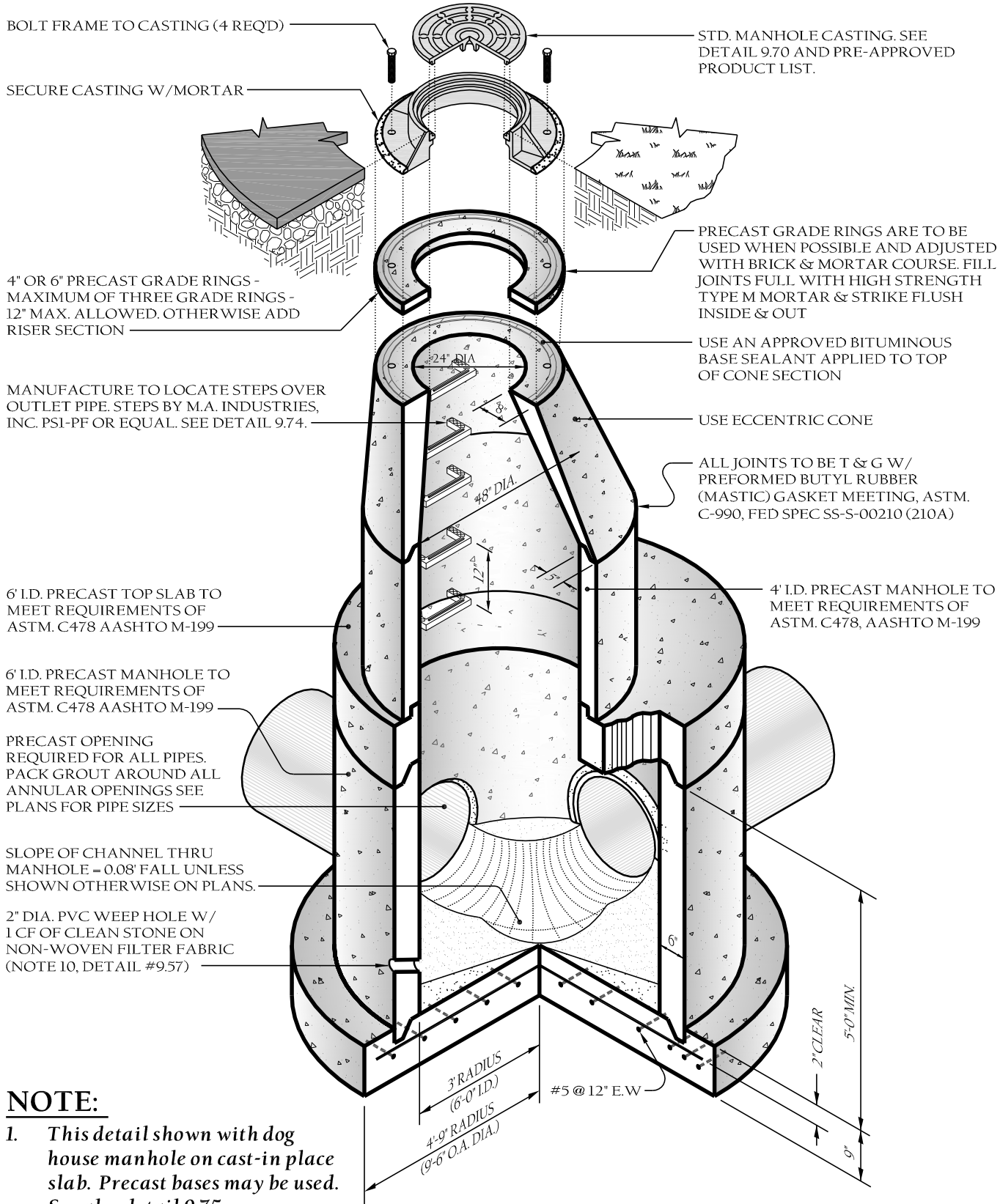

NOTE:
 1. This detail shown with dog house manhole on cast-in place slab. Precast bases may be used. See also detail 9.75.

TOWN of WAKE FOREST, NC
 Manual of Specifications, Standards and Design

PRECAST CONCRETE
6' TO 4' DIA. MHJB



Scale: Not To Scale	Detail #: 9.61
Revision Date: Feb., 2015	Sheet #: 1 of 1

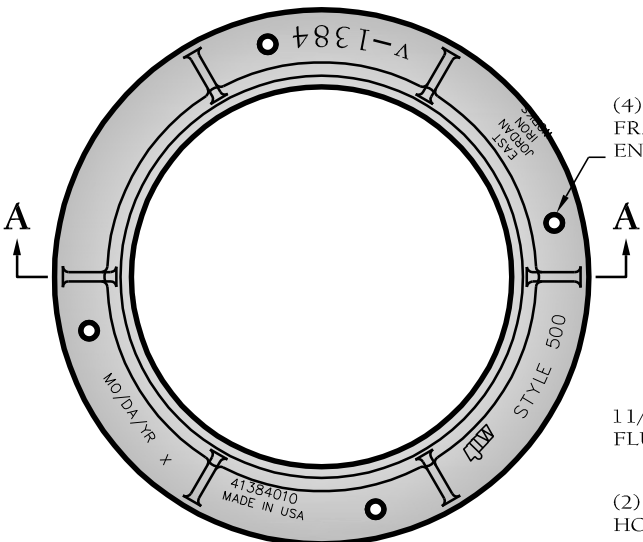

FRAME TOP

(4) 1" DIA. ANCHOR BOLT. HOLES EQUALLY SPACED. BOLT FRAME TO CONE SECTION WHEN ORDERED BY CITY ENGINEER OR WATER RESOURCES.

1 1/4" LETTERS (RECESSED FLUSH)

(2) CLOSED PICK HOLES

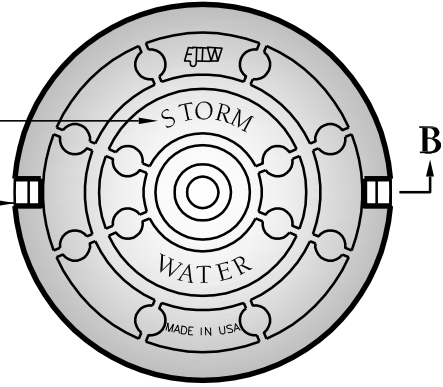

COVER FACE

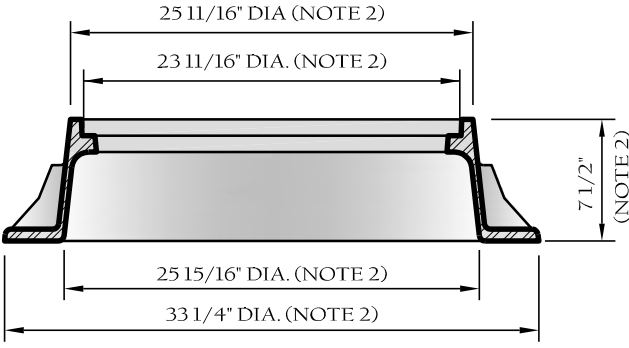

FRAME SECTION A-A



COVER SECTION B-B



ISOMETRICS

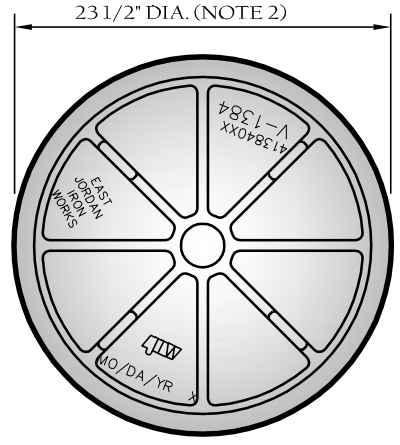
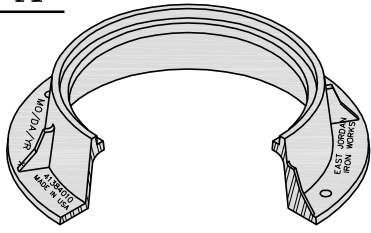

COVER BACK

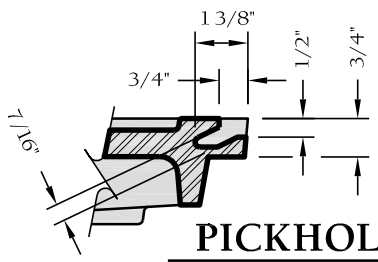

PICKHOLE

APPROVED MODELS	EAST JORDON V-1384 *
COVER WEIGHT	128 Lbs.
FRAME WEIGHT	153 Lbs.
LOAD RATING	HEAVY DUTY
MATERIAL	ASTM A 48 CLASS 35B
FINISH	UN COATED

* EJW OR APPROVED EQUAL SEE PRE-APPROVED PRODUCTS LIST

NOTES:

1. Frame & Cover weight may not deviate by more than -5.0%.
2. Iron casting to comply with AASHTO M306.



TOWN of WAKE FOREST, NC
Manual of Specifications, Standards and Design

STANDARD MANHOLE CASTING
STORM DRAINAGE STRUCTURES

Scale: Not To Scale	Detail #: 9.70
Revision Date: Feb., 2015	Sheet #: 1 of 1

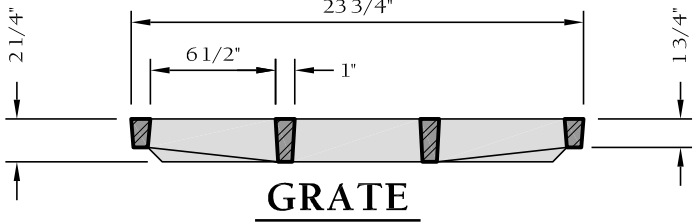
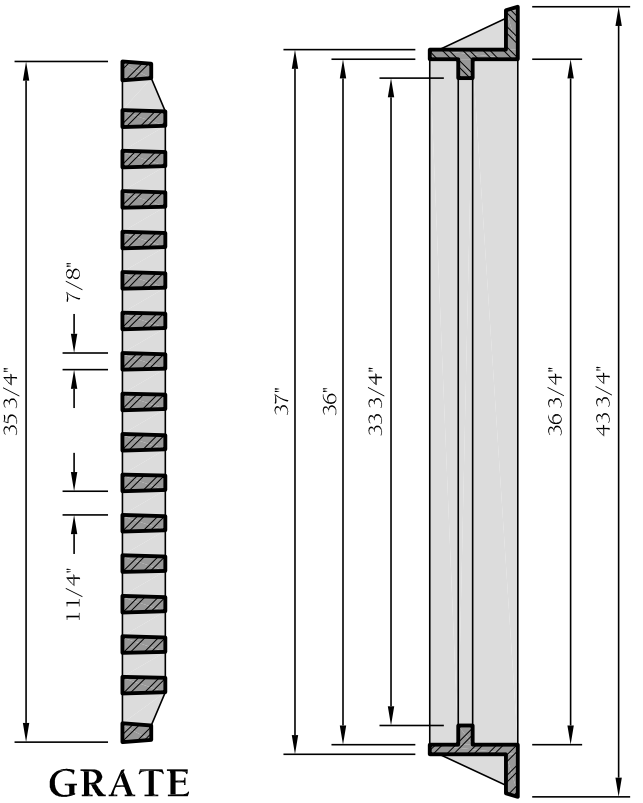
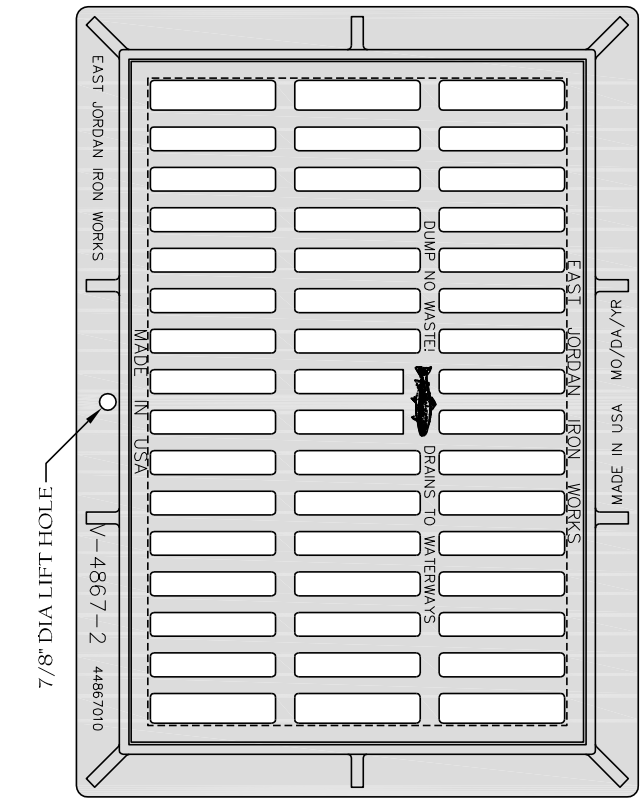

GRATE

FRAME

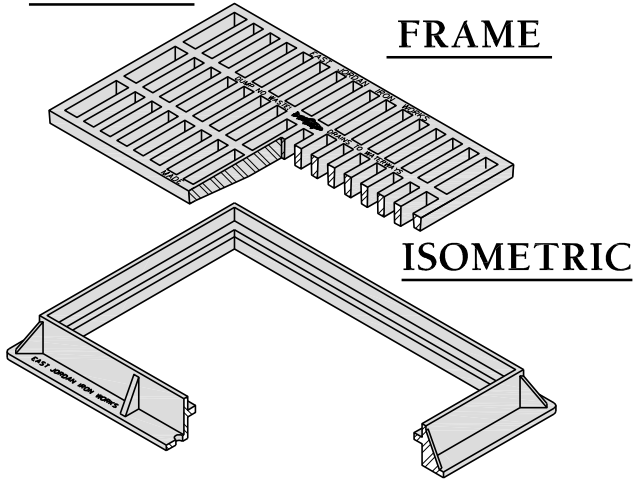

ISOMETRIC

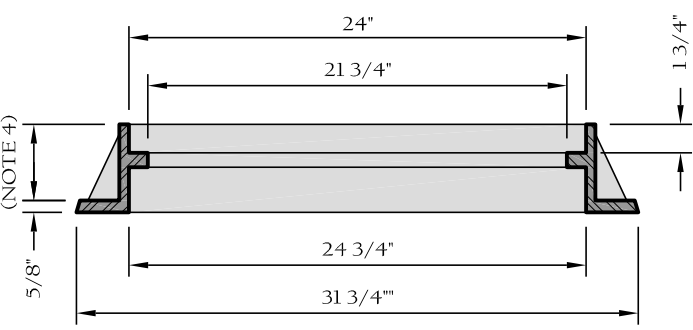

FRAME

APPROVED MODELS	EAST JORDAN V-4867-2 *
GRATE WEIGHT	190 Lbs.
FRAME WEIGHT	159 Lbs.
LOAD RATING	HEAVY DUTY
MATERIAL	ASTM A 48 CLASS 35B
FINISH	UNDIPPED

NOTES:

1. Frame & Cover weight may not deviate by more than -5.0%.
2. Iron casting to comply with AASHTO M306.
3. Net open area - 390 Sq. In.
4. For a 4" high frame, Use EJIW V-5660 or approved equal.

* EJIW OR APPROVED EQUAL. SEE PRE-APPROVED PRODUCT LIST



TOWN of WAKE FOREST, NC
Manual of Specifications, Standards and Design

STANDARD CATCH BASIN ASSEMBLY FRAME & GRATE

Scale: Not To Scale	Detail #: 9.71
Revision Date: Feb., 2015	Sheet #: 1 of 1

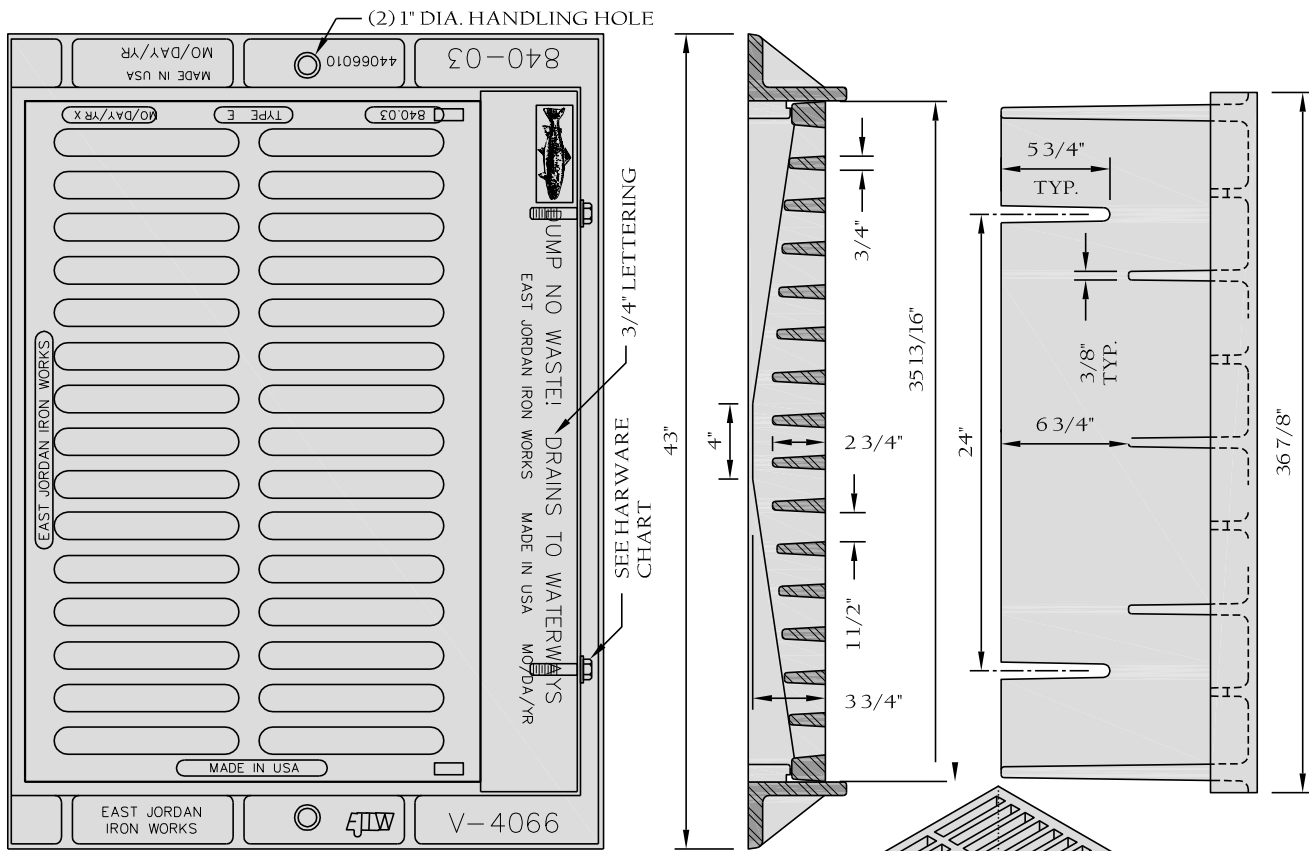

HARDWARE CHART:

(2) 00981234 BLT HX 5/8-11x2.5 ZN2
(2) 00981290 NUT HX 5/8-11 ZN
(4) 00981291 WSHR 5/8 ID 1.75 OD ZN

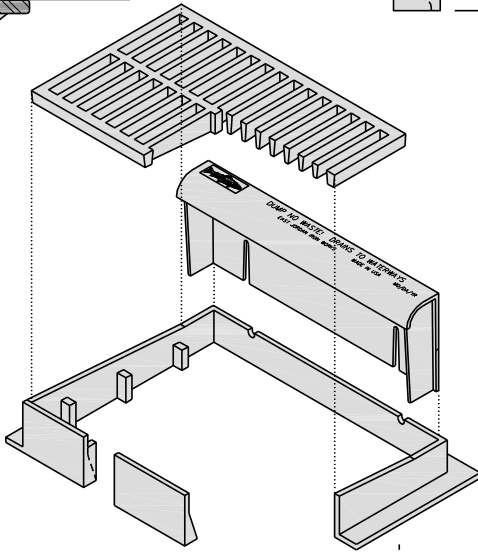
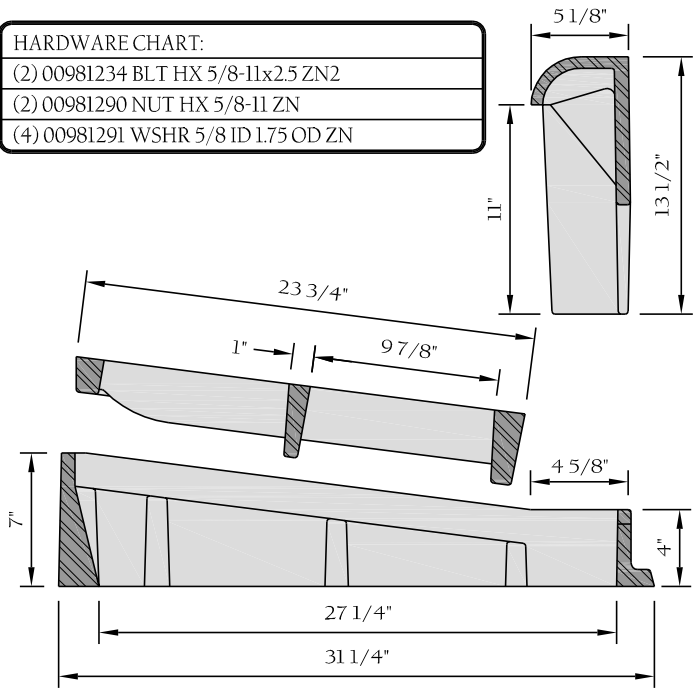

APPROVED MODELS	EAST JORDAN V-4066-1 *
GRATE WEIGHT	218 Lbs.
FRAME WEIGHT	215 Lbs.
BACK WEIGHT	140 Lbs.
LOAD RATING	HEAVY DUTY
MATERIAL	ASTM A 48 CLASS 35B
FINISH	UNDIPPED

NOTES:

1. Frame & Cover weight may not deviate by more than -5.0%.
2. Iron casting to comply with AASHTO M306.

* EJW OR APPROVED EQUAL. SEE PRE-APPROVED PRODUCT LIST.



TOWN of WAKE FOREST, NC
Manual of Specifications, Standards and Design

STANDARD COMBINATION
FRAME, HOOD & GRATE (NCDOT 840.03)

Scale: Not To Scale	Detail #: 9.72
Revision Date: Feb., 2015	Sheet #: 1 of 1



TOWN of
WAKE FOREST

TOWN of WAKE FOREST, NC
Manual of Specifications, Standards and Design

RESERVED
FUTURE DETAIL

Scale:
Not To Scale

Detail #:
9.73

Revision Date:
Feb., 2015

Sheet #:
1 of 1

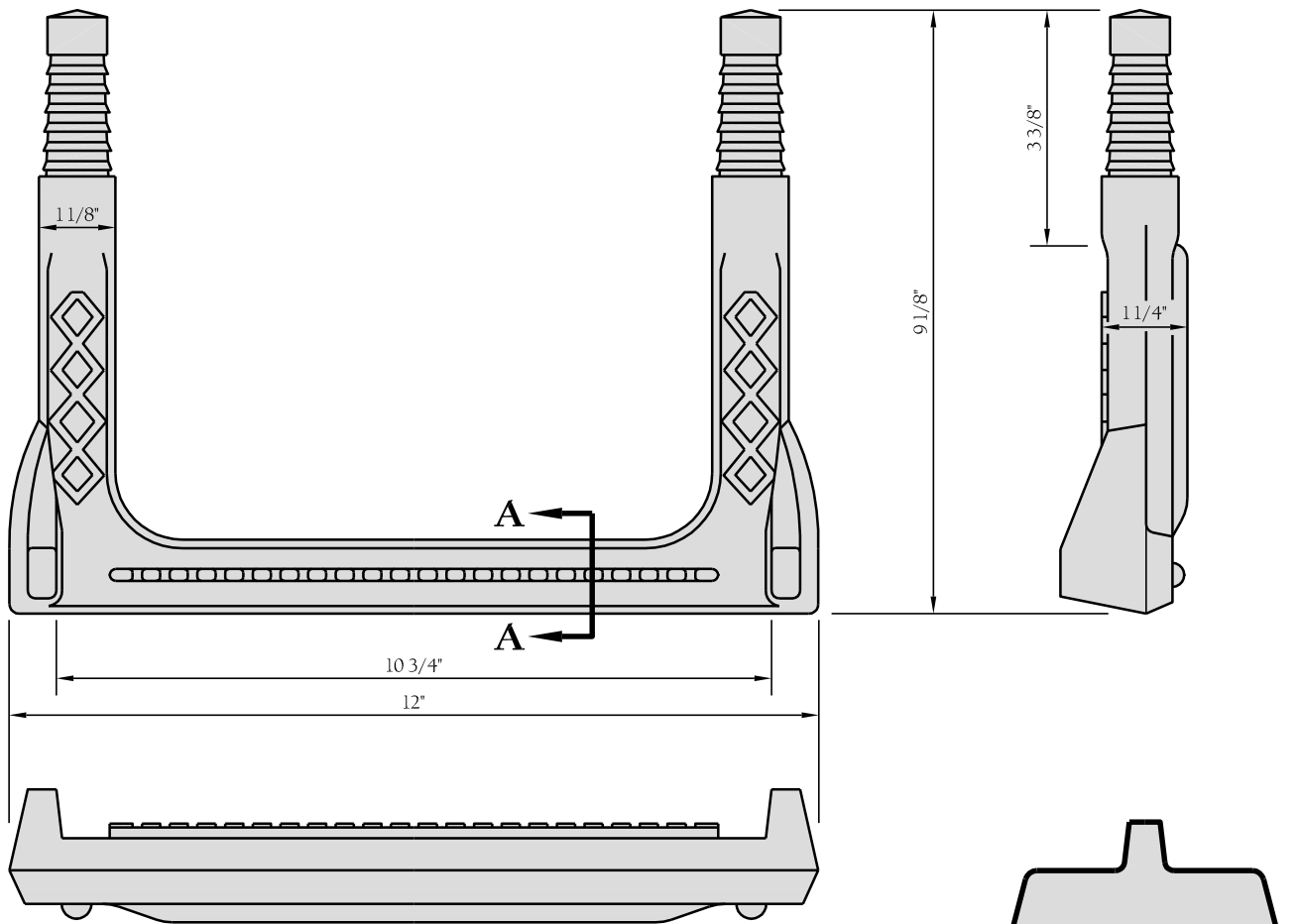

COPOLYMER POLYPROPYLENE PLASTIC
1/2" GRADE 60 STEEL REINFORCEMENT

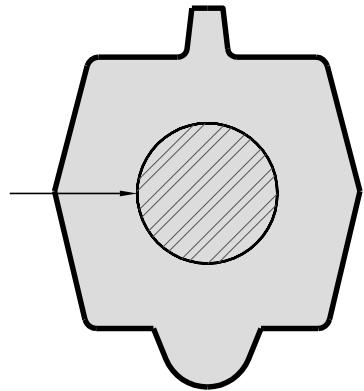
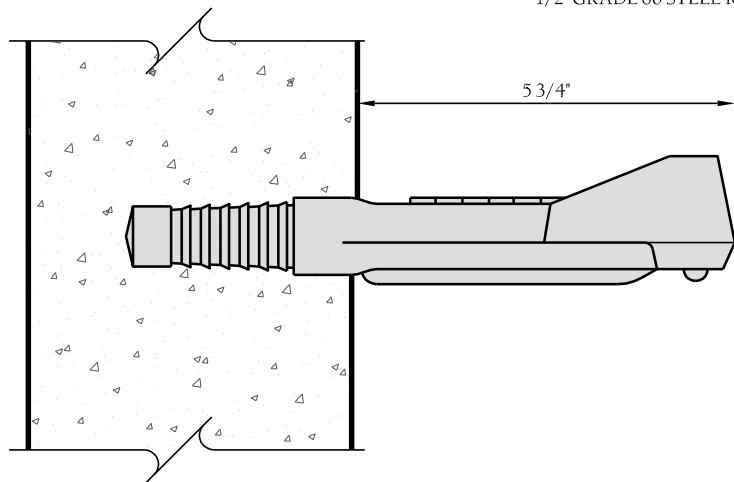

SECTION A-A

NOTES:

1. Step shown is PS1-PF BY M.A. Industries Inc. Peachtree City, GA. Alternate may be used if approved by town.



TOWN of
WAKE FOREST

TOWN of WAKE FOREST, NC
Manual of Specifications, Standards and Design

**MANHOLE STEP
DETAIL**

Scale:
Not To Scale

Detail #:
9.74

Revision Date:
Feb., 2015

Sheet #:
1 of 1

To calculate the closest possible distance between two holes (openings) on the same horizontal centerline, use the following formula:

- A = Distance between holes (in degrees)
- B = Angle between centerline of pipes
- C = Degrees for hole number one from chart below
- D = Degrees for hole number two from chart below

If A < 0, the openings are overlapping
 If A > 0, A = the distance between holes (in degrees)

4' DIA:

$A = 90 - 1/2(95+95) = 90 - 95 = -5$, Holes too close

5' DIA:

$A = 90 - 1/2(75+75) = 90 - 75 = 15$, O.K. for 5' dia.

There are 15° of angle between holes which is 7 7/8".

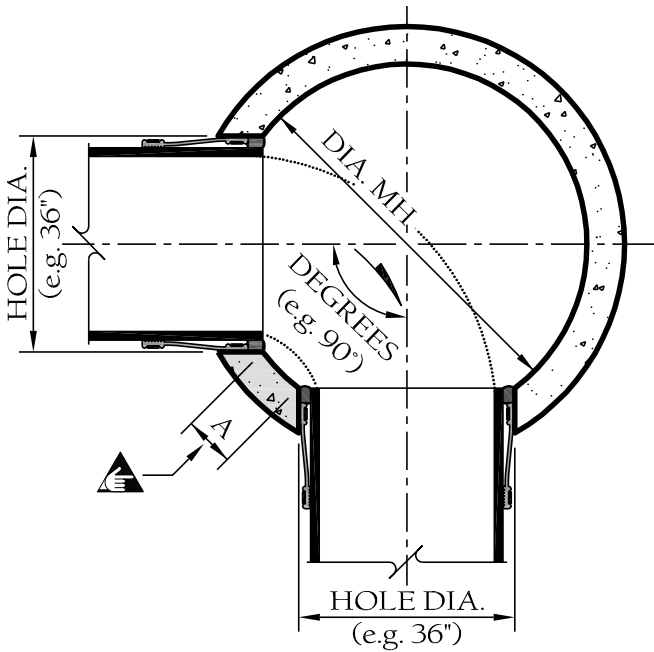

4' Dia. MH	
Hole Dia.	Degrees
12"	28°
12"	28°
18"	45°
24"	60°
30"	76°
36"	95°

8' Dia. MH	
Hole Dia.	Degrees
12"	15°
18"	22°
24"	28°
36"	44°
40"	48°
42"	52°
48"	60°
55"	68°
60"	80°
70"	90°
78"	108°

5' Dia. MH	
Hole Dia.	Degrees
12"	22°
18"	35°
24"	48°
30"	62.6°
36"	75°
40"	82°
48"	108°

10' Dia. MH	
Hole Dia.	Degrees
12"	12°
18"	18°
24"	24°
36"	36°
40"	38°
48"	46°
55"	55°
62"	62°
70"	70°
78"	80°

6' Dia. MH	
Hole Dia.	Degrees
12"	20°
16"	25°
20"	32°
24"	38°
36"	60°
40"	65°
43"	70°
48"	84°
55"	98°
63"	125°



TOWN of WAKE FOREST, NC Manual of Specifications, Standards and Design

DISTANCE BETWEEN TWO HOLES (OPENINGS) FORMULA

Scale:
Not To Scale

Detail #:
9.75

Revision Date:
Feb., 2015

Sheet #:
1 of 1

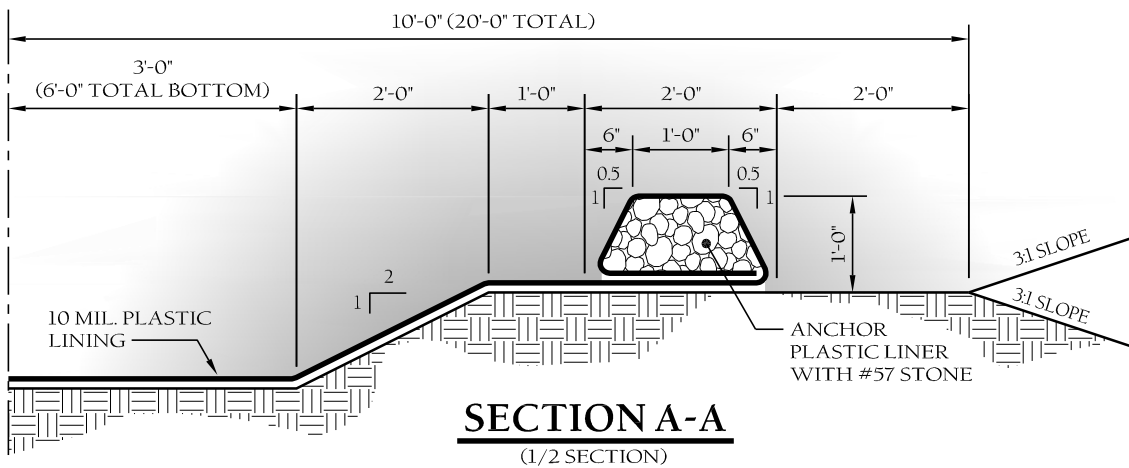
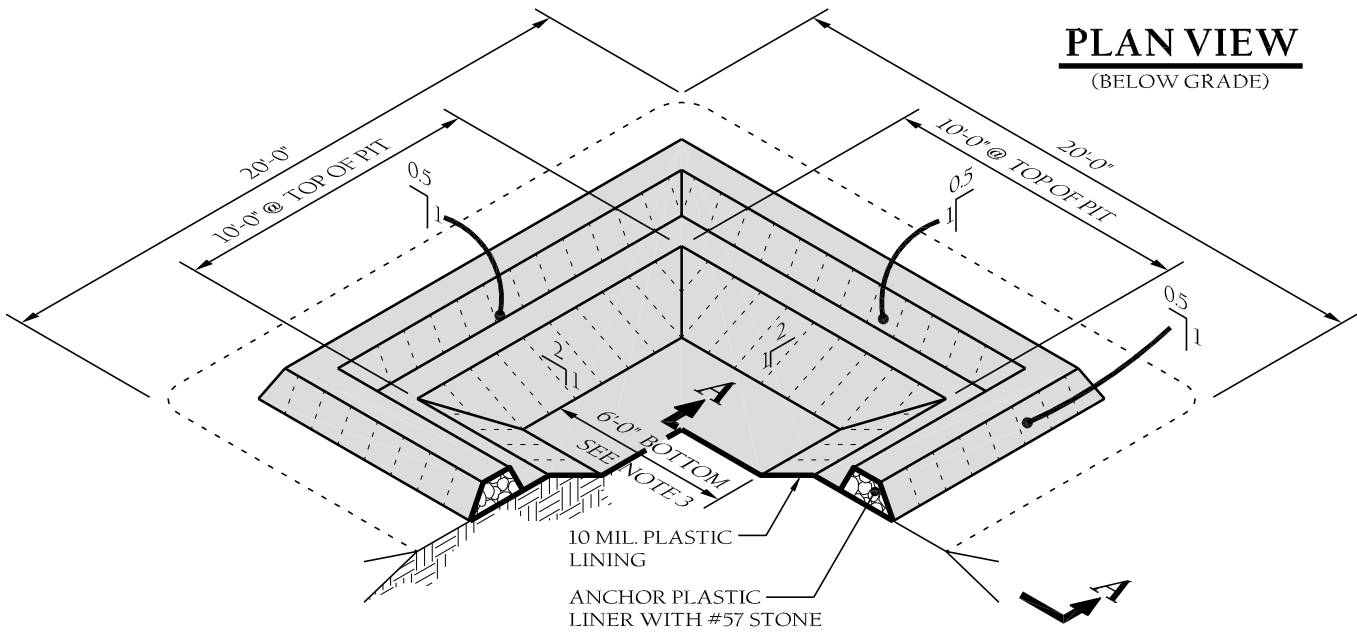

EXCAVATED PIT WITH STONE SUPPORT

NOT TO SCALE

STONE SUPPORT NOTES:

1. Actual layout to be determined in field.
2. The "concrete washout" sign shall be installed within 30 ft of the temporary concrete washout facility.
3. Pit capacity is minimum of 6 cu ft per 10 cu yd of concrete.
4. Contractor to coordinate with usage contracting officer for proper disposal of concrete.



TOWN of WAKE FOREST, NC
Manual of Specifications, Standards and Design

**CONCRETE WASHOUT
PIT DETAIL**

Scale:
Not To Scale

Detail #:
9.76

Revision Date:
Feb., 2015

Sheet #:
1 of 4

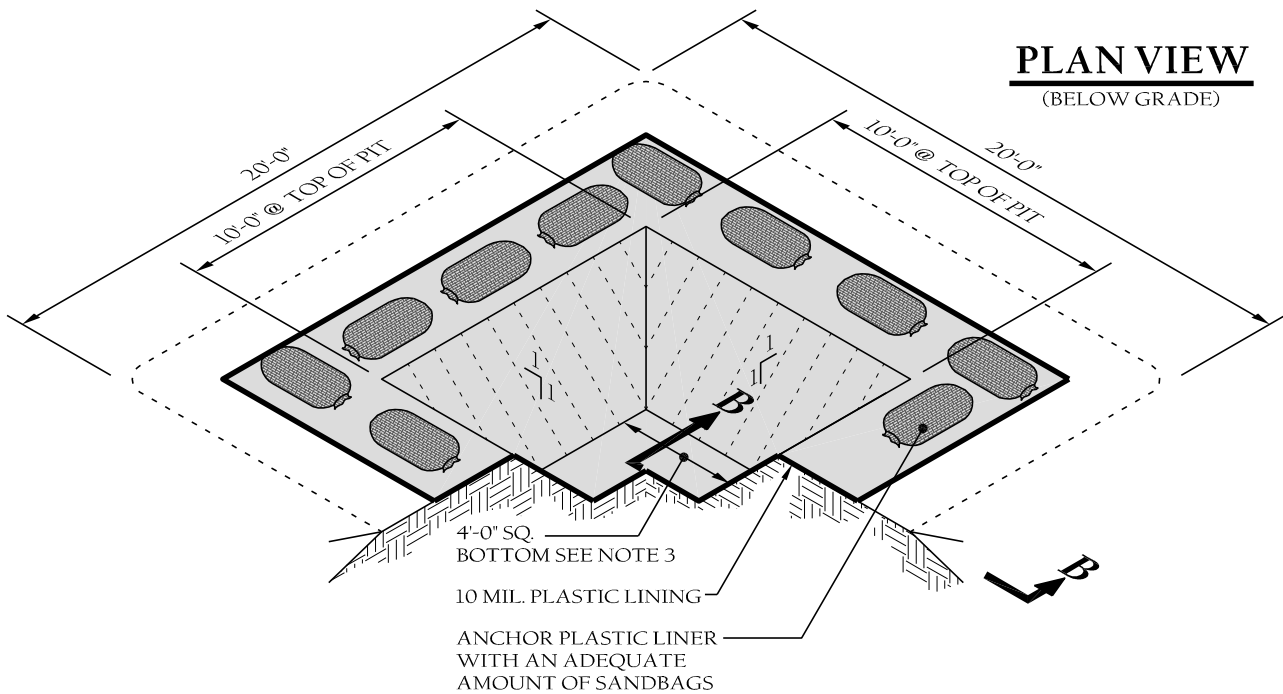

PLAN VIEW
(BELOW GRADE)

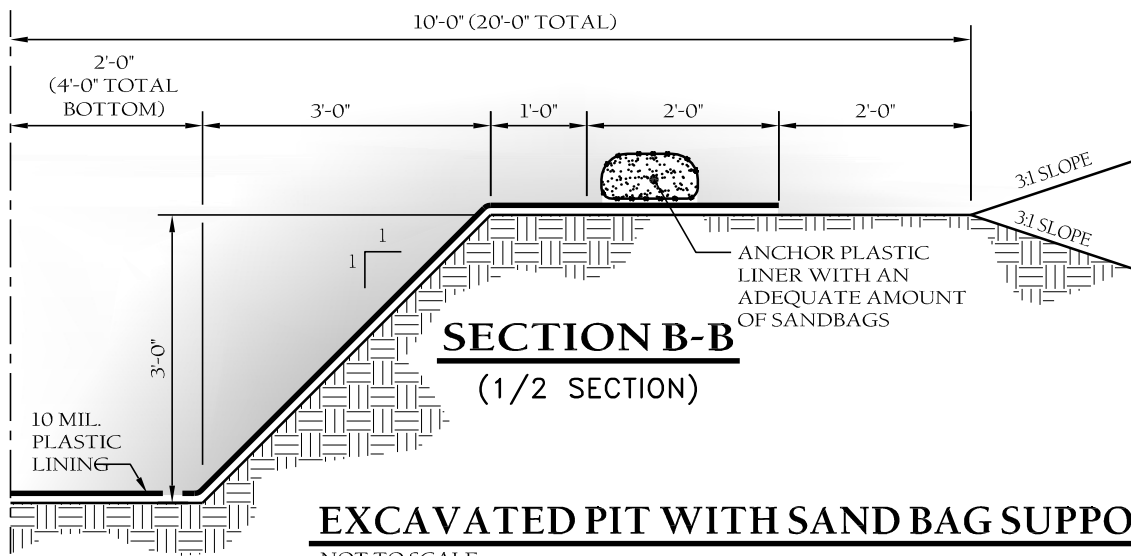

SECTION B-B
(1/2 SECTION)

EXCAVATED PIT WITH SAND BAG SUPPORT
NOT TO SCALE

SAND BAG SUPPORT NOTES:

1. Actual layout to be determined in field.
2. The "concrete washout" sign shall be installed within 30 ft of the temporary concrete washout facility.
3. Pit capacity is minimum of 6 cu ft per 10 cu yd of concrete.
4. Contractor to coordinate with usage contracting officer for proper disposal of concrete.



TOWN of WAKE FOREST, NC
Manual of Specifications, Standards and Design

**CONCRETE WASHOUT
PIT DETAIL**

Scale: Not To Scale	Detail #: 9.76
Revision Date: Feb., 2015	Sheet #: 2 of 4

PLAN VIEW
(ABOVE GRADE)

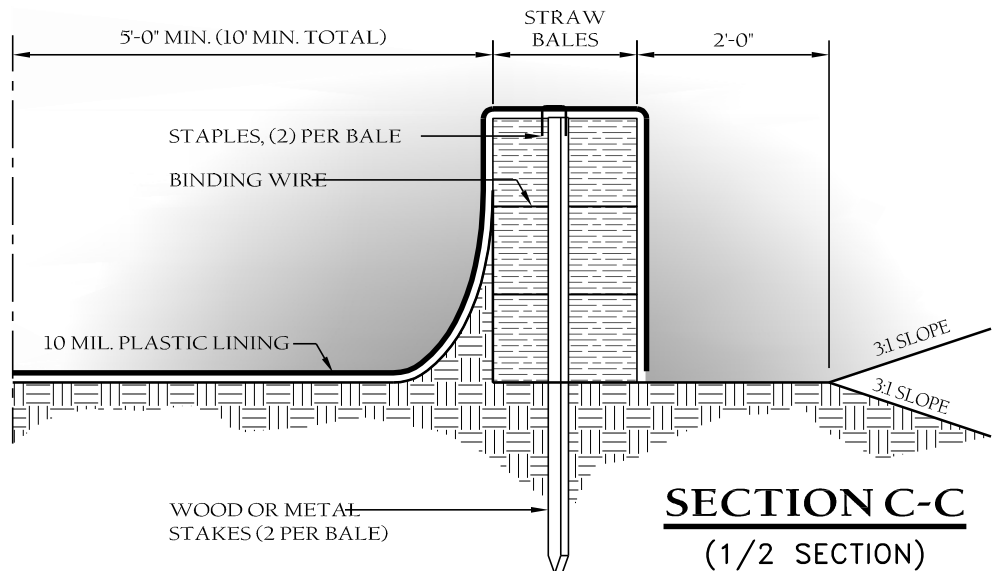
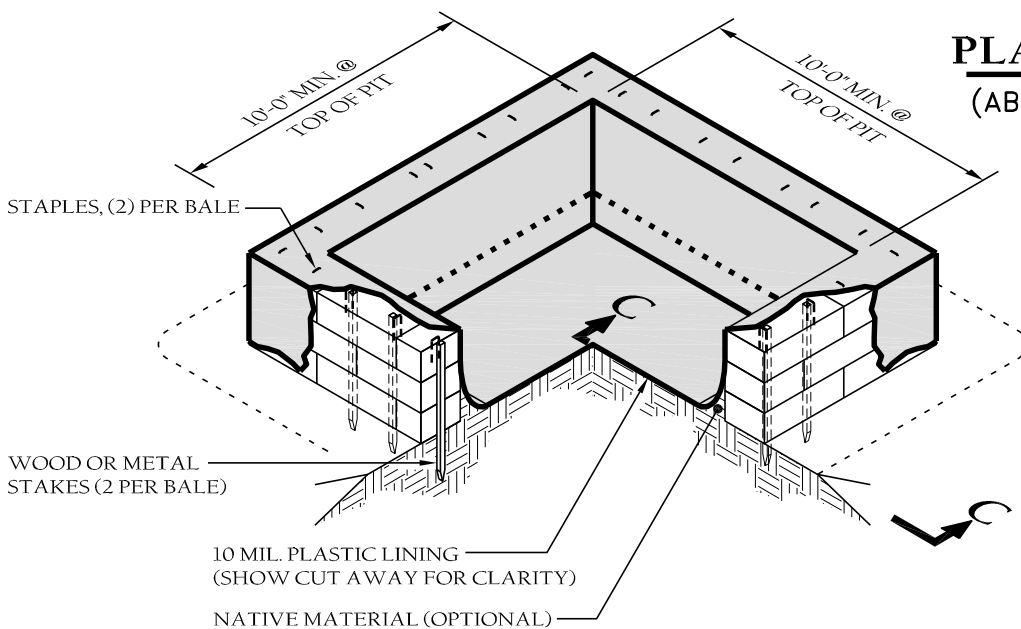

ELEVATED PIT WITH STRAW BALE DETENTION WALLS
NOT TO SCALE

STRAW BALE DETENTION NOTES:

1. Actual layout to be determined in field.
2. The "concrete washout" sign shall be installed within 30 ft of the temporary concrete washout facility.
3. Pit capacity is minimum of 6 cu ft per 10 cu yd of concrete.
4. Contractor to coordinate with usage contracting officer for proper disposal of concrete.



TOWN of WAKE FOREST, NC
Manual of Specifications, Standards and Design

**CONCRETE WASHOUT
PIT DETAIL**

Scale: Not To Scale	Detail #: 9.76
Revision Date: Feb., 2015	Sheet #: 3 of 4

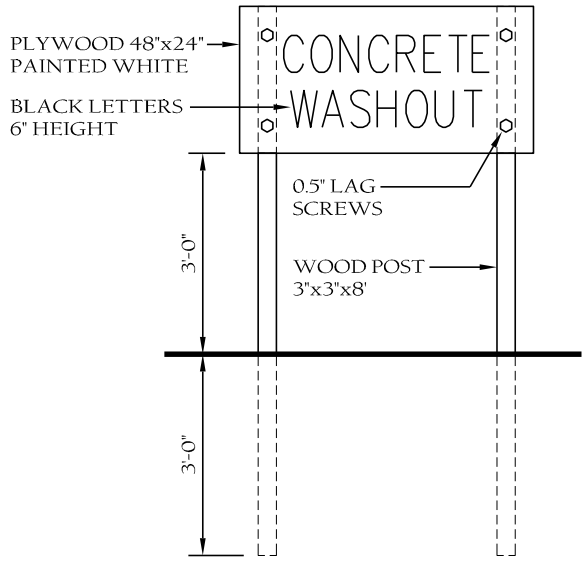

SIGN DETAIL
(OR EQUIVILANT)

CONCRETE WASHOUT DETAIL NOTES

Concrete washouts are used to contain concrete and liquids when the chutes of concrete mixers and hoppers of concrete pumps are rinsed out after delivery. The washout facilities consolidate solids for easier disposal and prevent runoff of liquids. The wash water is alkaline and contains high levels of chromium, which can leach into the ground and contaminate groundwater. It can also migrate to a storm drain, which can increase the pH of area waters and harm aquatic life. Revised NPDES and NC General Construction Permits require the use of concrete washout areas on all sites using concrete:

1. No concrete or cement slurry shall be discharged from the site.
2. Any hardened concrete residue shall be disposed of, or recycled on site, in accordance with local and state solid waste regulations.
3. Concrete washout area to be minimum 50' from storm drain inlets and surface waters (ie, detention pond, ditches, etc).
4. Prefabricated washout container or pit equal detail provided may be used if approved by Engineer.
5. Install concrete washout pit at all construction entrances used by concrete trucks.
6. Dimensions may be modified to fit topography. Provide minimum 100 Sf. of surface area level.
7. Locations shown on plans are for illustrative purposes only. Contractor shall determine final number of pits required, and their placement.
8. Inspection:
 - a. Contractor to check all concrete washout facilities daily to determine if they have been filled to 75% capacity, which is when materials need to be removed.
 - b. Both above- and below- ground self-installed washouts should be inspected daily to ensure that plastic linings are intact and sidewalls have not been damaged by construction activities. Contractor to repair plastic lining as needed.
 - c. Prefabricated washout containers should be inspected daily as well to ensure the container is not leaking or nearing 75 percent capacity.
 - d. Inspectors should also note whether the facilities are being used regularly.
6. Material Removal:
 - a. Concrete washouts are designed to promote evaporation where feasible. However, if stored liquids have not evaporated and the washout is nearing capacity, vacuum and dispose of them in an approved manner - check with the local sanitary sewer authority to determine if there are special disposal requirements for concrete wash water.
 - b. Remove liquids or cover the structures before predicted rainstorms to prevent overflows. Companies that offer prefabricated and watertight washout containers generally offer a vacuum service to remove the liquid material.
 - c. Contractor to remove hardened solids or reuse onsite or haul them away for recycling.
 - d. When removing materials from the concrete washout, building a new structure or, if the previous structure is still intact, Contractor is to inspect the structure for signs of weakening or damage and make any necessary repairs. Line the structure with new plastic that is free of holes or tears and replace signage if necessary. It is very important that new plastic is used after every cleaning because pumps and concrete removal equipment can damage the existing liner.
7. At completion of project, washout area to be backfilled and graded to be level with existing grade..
8. General Contractor is to educate concrete subcontractors, post signage indicating the location and designated use of these areas, and provide careful oversight to inspect for evidence of improper dumping of concrete waste and wash water. Contractor should include requirements in contracts with concrete delivery companies that drivers must use designated concrete washout facilities.



TOWN of WAKE FOREST, NC
Manual of Specifications, Standards and Design

CONCRETE WASHOUT
PIT DETAIL

Scale: Not To Scale	Detail #: 9.76
Revision Date: Feb., 2015	Sheet #: 4 of 4